

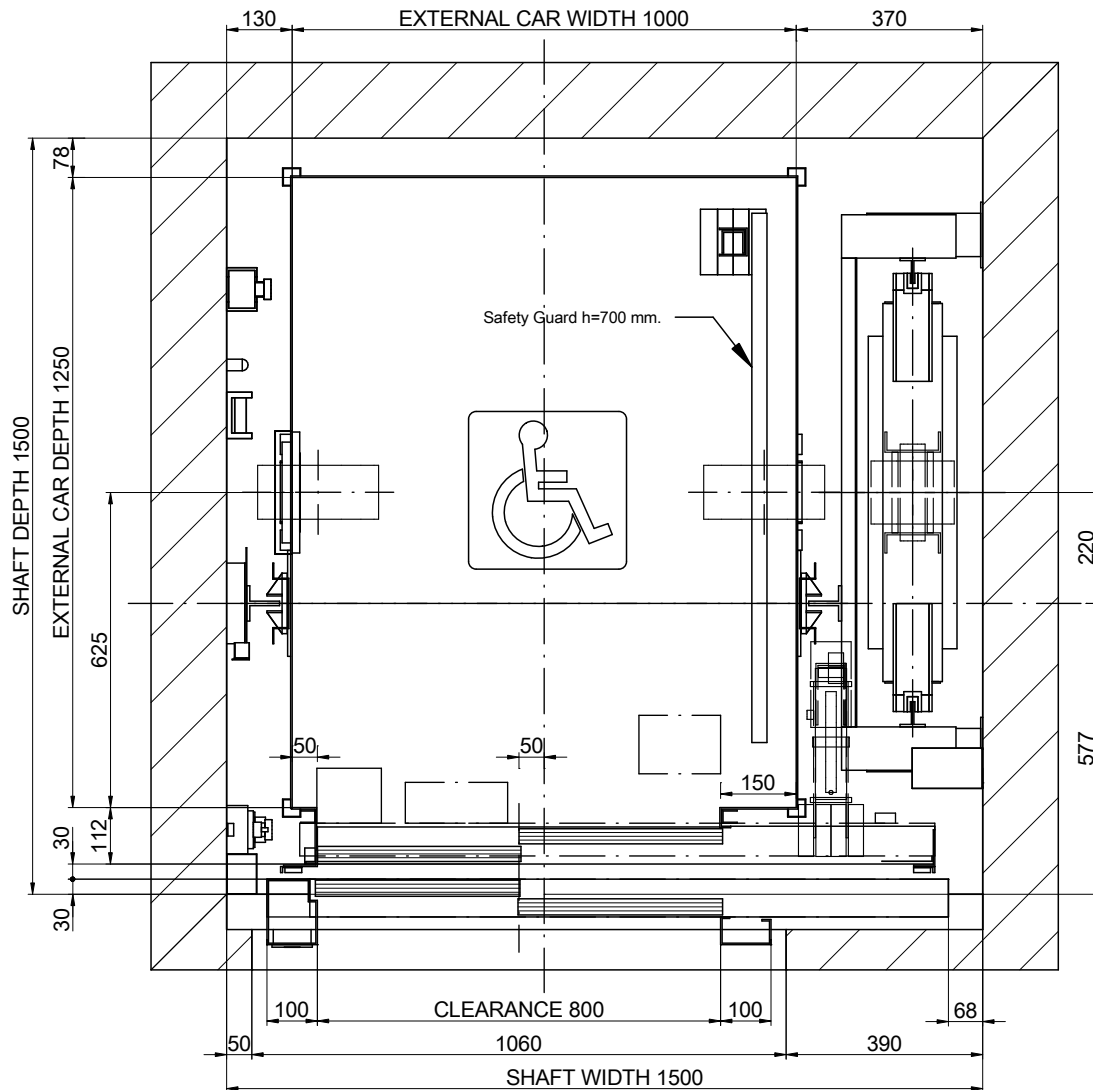

01-PLAN VIEW



DRAWING	DATE	REV.	SHEET	[*] Unbounded dimensions in drawings are indicative and not binding.	
MP	2017	00	1/8		
MODEL LIFT:				REFERENCE:	
MP GO! EVOLUTION				MPGO!EVOLUTION480ST2_EN	
CAPACITY: [N° PERSONS]				6	CLIENT: WORK SITUATION:
NOMINAL LOAD: [kg]				480	
SPEED: [m/s]				1	
FREQUENCY: [Hz]				50	
TENSION: [V]				380V [Three-phase]	
MP LIFTS					

01B-PLAN VIEW

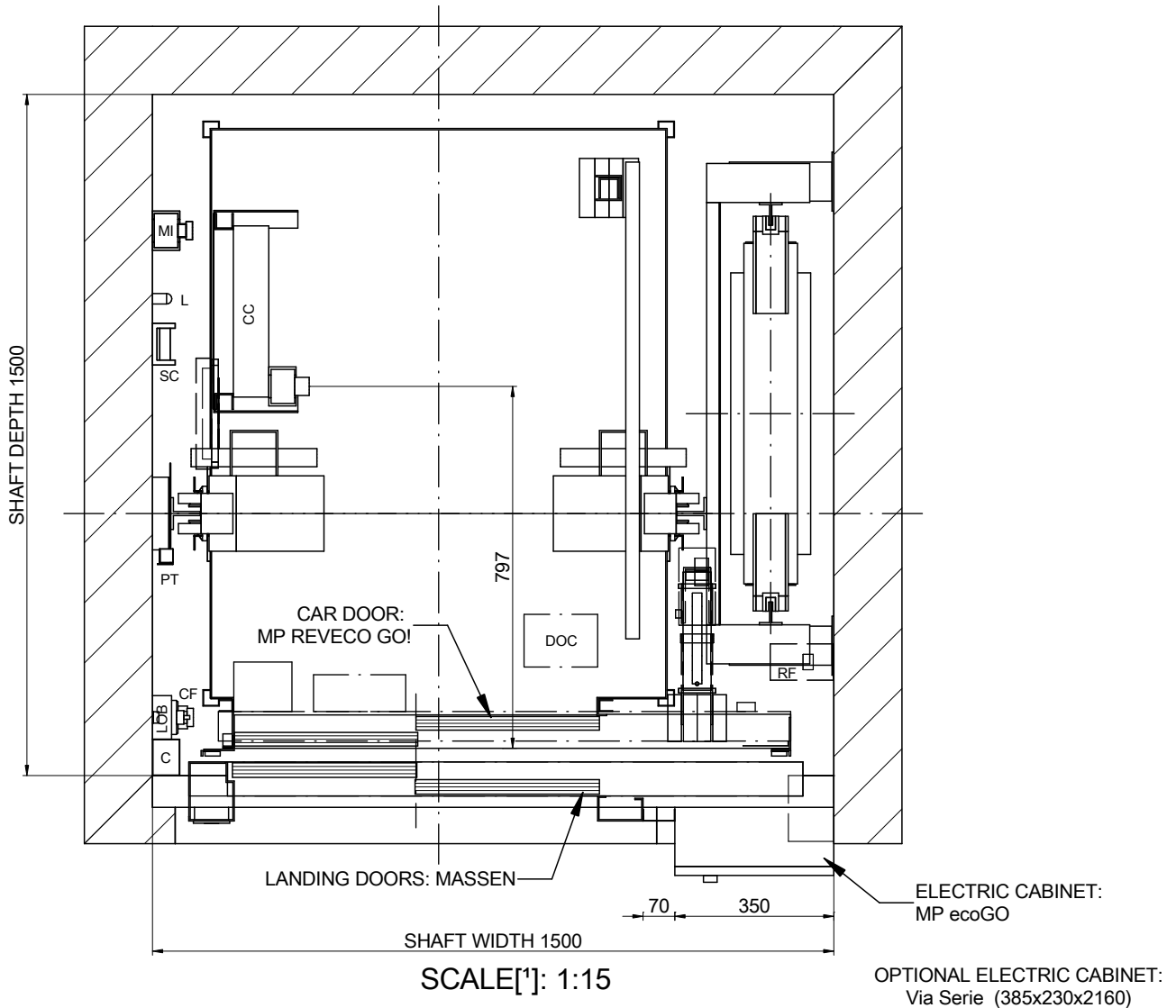

NOMENCLATURE

C: Wiring channel
 CC: Car ceiling connection box
 CF: Pit box
 CL: Shaft light switch
 DOC: Operator control box
 L: Lamp
 LOB: Pushbutton control board
 MI: Inspection control station
 PT: Fixed cam
 RF: Brake resistor
 ST: Stopping device
 SC: Travelling cable support

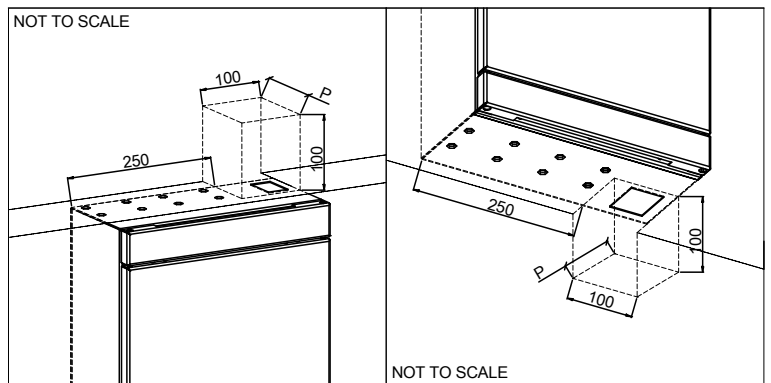

DRAWING	DATE	REV.	SHEET	[*] Unbounded dimensions in drawings are indicative and not binding. REFERENCE: MPGO!EVOLUTION480ST2_EN	
MP	2017	00	2/8		
MODEL LIFT:				CLIENT:	WORK SITUATION:
MP GO! EVOLUTION					
CAPACITY: [N° PERSONS]			6	MP LIFTS	
NOMINAL LOAD: [kg]			480		
SPEED: [m/s]			1		
FREQUENCY: [Hz]			50		
TENSION: [V]			380V [Three-phase]		

02-SIDE VERTICAL SECTION

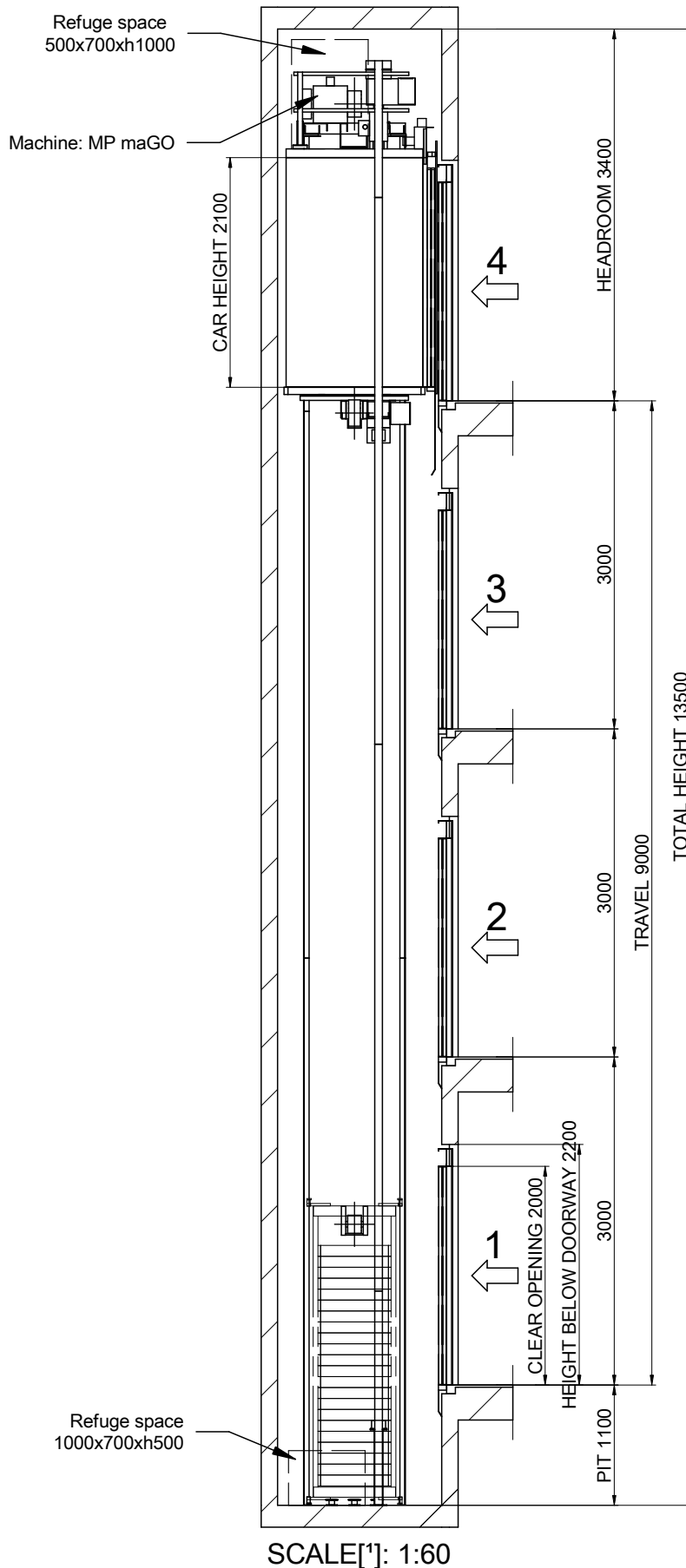

DRAWING		DATE	REV.	SHEET	[*] Unbounded dimensions in drawings are indicative and not binding.
MP	2017	00	3/8	REFERENCE: MPGOIEVOLUTION480ST2_EN	
MODEL LIFT:		MP GOI EVOLUTION			
CAPACITY: [N° PERSONS]		6			
NOMINAL LOAD: [kg]		480			
SPEED: [m/s]		1			
FREQUENCY: [Hz]		50			
TENSION: [V]		380V [Three-phase]			
CLIENT: WORK SITUATION:					MP LIFTS

Flat and levelled floor, protected against water leaking.
 [EN81-20:2014 5.2.1.9]
 Foresee pit access device
 [EN81-20:2014 5.2.2.4]
 Stop device
 [EN81-20:2014 5.2.1.5.1. a]
 Inspection control station.
 [EN81-20:2014 5.2.1.5.1. b]
 Power supply
 [EN81-20:2014 5.2.1.5.1. c]
 Light switch commuted with the cabinet.
 [EN81-20:2014 5.2.1.5.1. d]

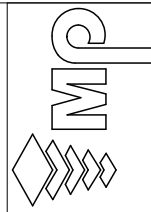

03B-FIXING DETAILS IN HEADROOM

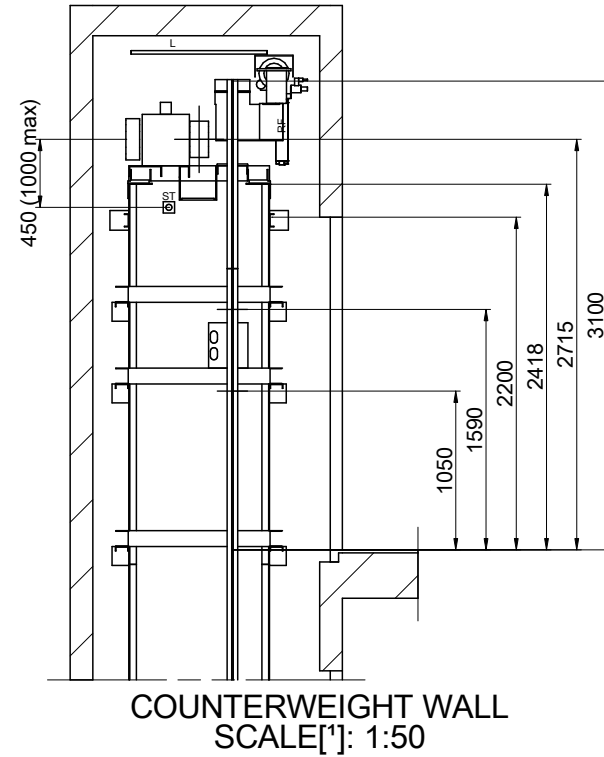
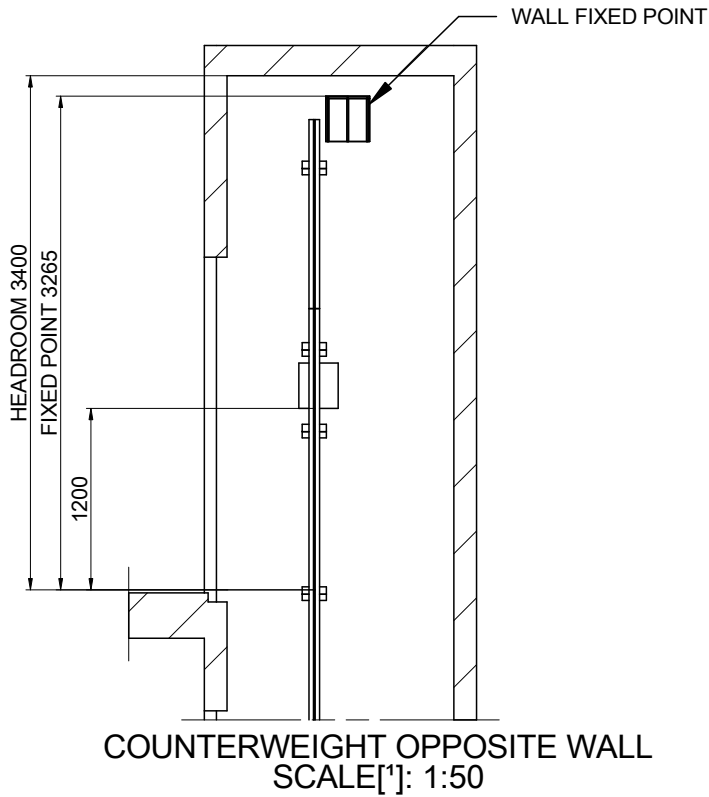

DRAWING	DATE	REV.	SHEET
MP	2017	00	4/8
MODEL LIFT:			
MP GO! EVOLUTION			
CAPACITY: [N° PERSONS]			6
NOMINAL LOAD: [kg]			480
SPEED: [m/s]			1
FREQUENCY: [Hz]			50
TENSION: [V]		380V [Three-phase]	

[*] Unbounded dimensions in drawings are indicative and not binding.

REFERENCE:
MPGO!EVOLUTION480ST2_EN

CLIENT:
WORK SITUATION:



MP LIFTS

04-BEAM AND LIFTING HOOKS

POSITION OF REMOVABLE LIFTING HOOKS ABLE TO SUPPORT
1000 kg EACH ONE SUPPLIED BY CONSTRUCTOR
(RECOMMENDED POSITION LOADHOOKS)

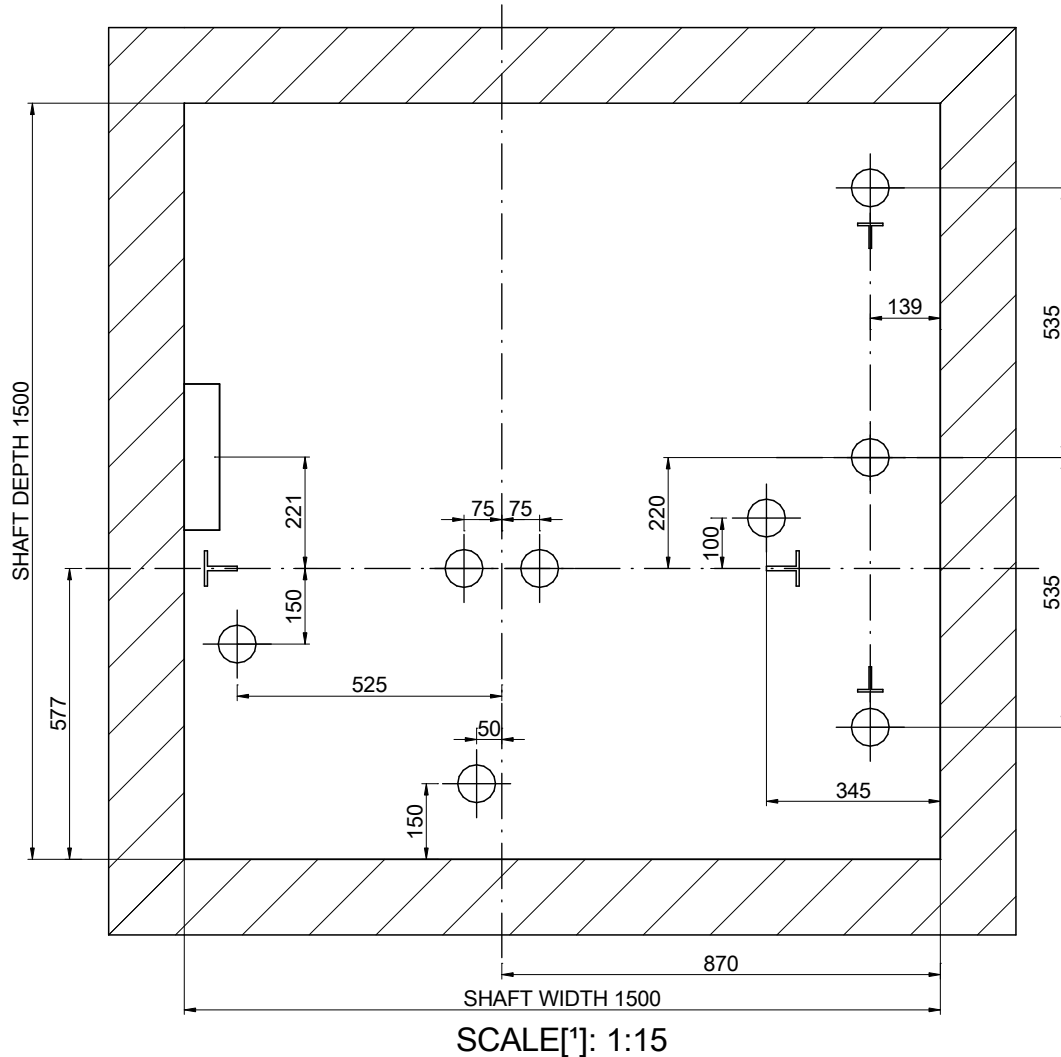

DRAWING	DATE	REV.	SHEET	[*] Unbounded dimensions in drawings are indicative and not binding.	
MP	2017	00	5/8	REFERENCE: MPGO!EVOLUTION480ST2_EN	
MODEL LIFT:				CLIENT:	
MP GO! EVOLUTION				WORK SITUATION:	
CAPACITY: [N° PERSONS]			6	MP LIFTS	
NOMINAL LOAD: [kg]			480		
SPEED: [m/s]			1		
FREQUENCY: [Hz]			50		
TENSION: [V]			380V [Three-phase]		

05-PIT LAYOUT

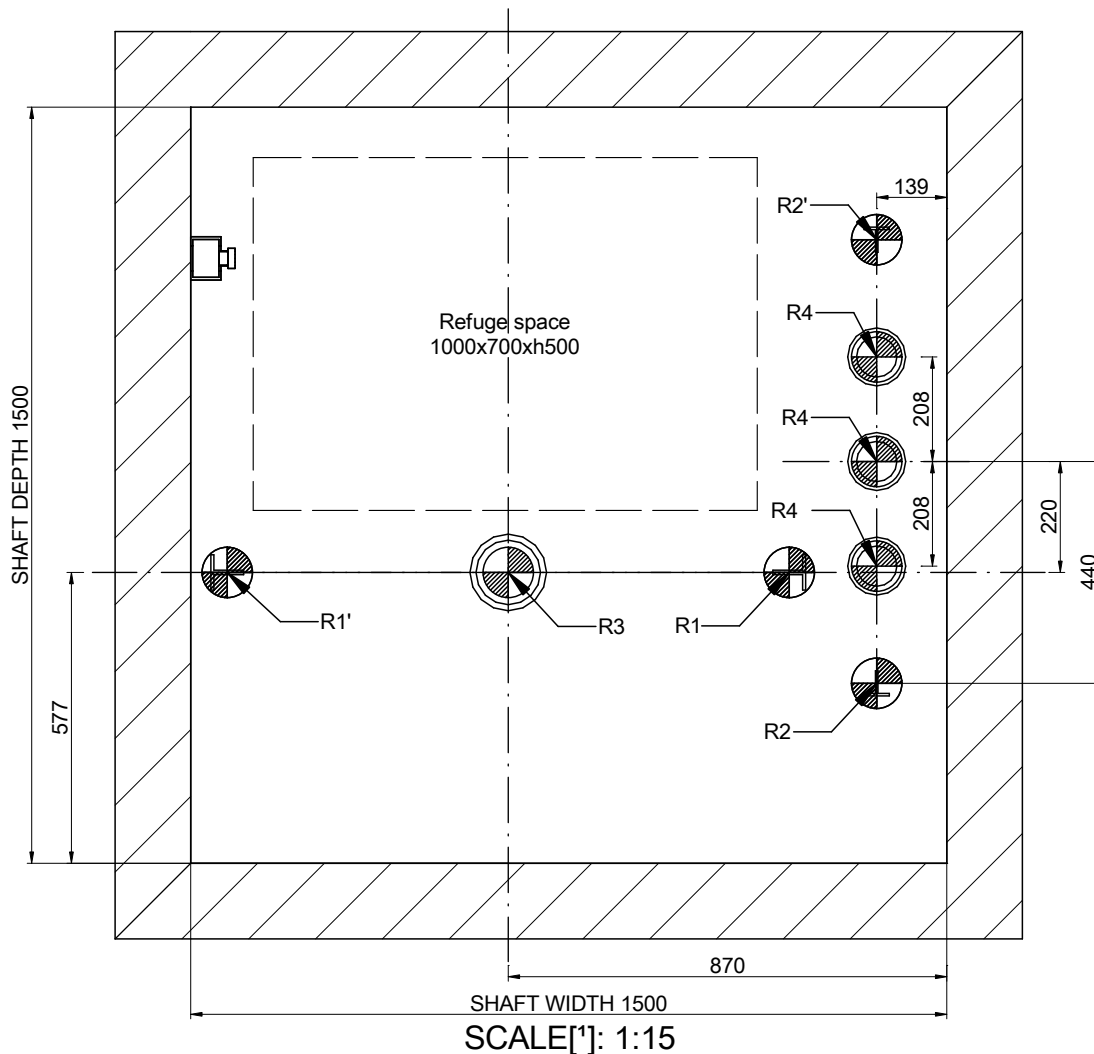



REACTIONS [N] [max.]			
R1	28000	R2	20500
R1'	25000	R2'	21000
R3	57000	R4	16000
N	1800	T	850

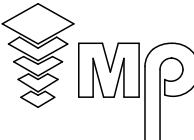

DRAWING	DATE	REV.	SHEET	[*] Unbounded dimensions in drawings are indicative and not binding.	
MP	2017	00	6/8		
MODEL LIFT:				REFERENCE:	CLIENT: WORK SITUATION:
MP GO! EVOLUTION				MPGO!EVOLUTION480ST2_EN	
CAPACITY: [N° PERSONS]			6		
NOMINAL LOAD: [kg]			480		
SPEED: [m/s]			1		
FREQUENCY: [Hz]			50		
TENSION: [V]			380V [Three-phase]	MP LIFTS	

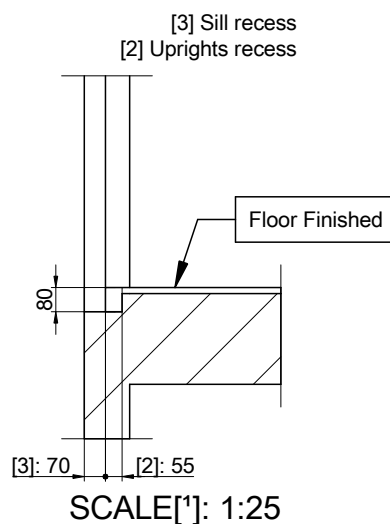
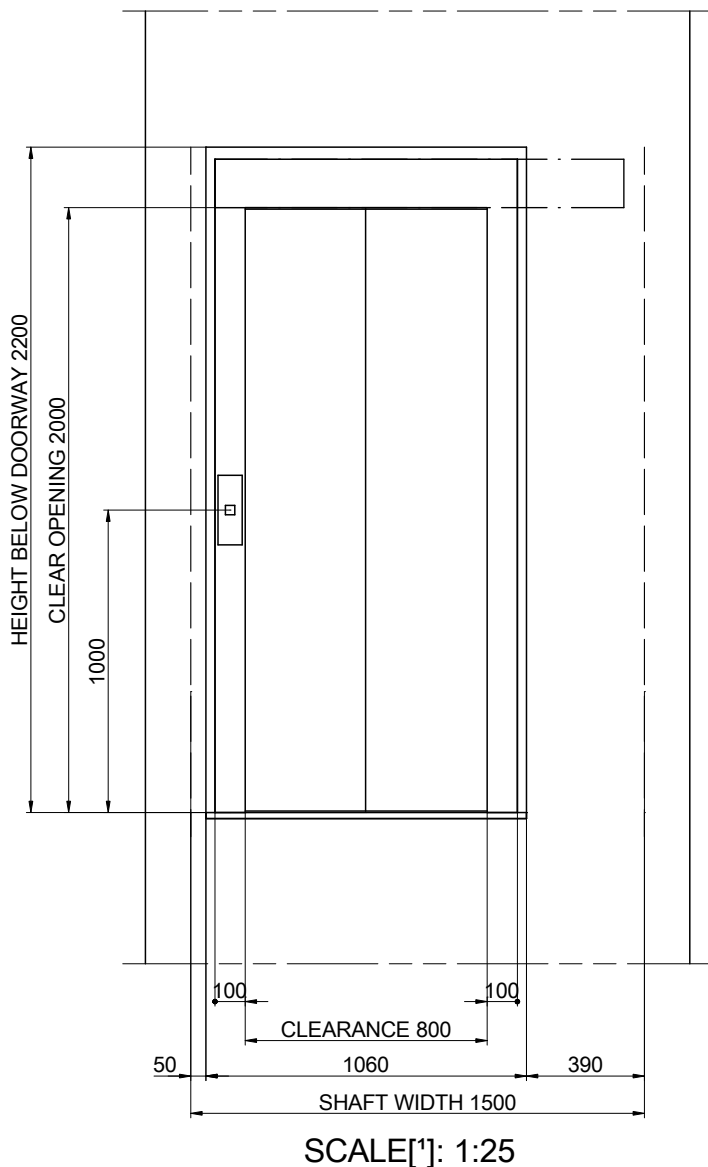
06-DOOR HOLE DETAIL



DRAWING	DATE	REV.	SHEET	[*] Unbounded dimensions in drawings are indicative and not binding.	
MP	2017	00	7/8	REFERENCE: MPGO!EVOLUTION480ST2_EN	
MODEL LIFT:				CLIENT: WORK SITUATION:	
MP GO! EVOLUTION					
CAPACITY: [N° PERSONS]			6		
NOMINAL LOAD: [kg]			480		
SPEED: [m/s]			1		
FREQUENCY: [Hz]			50		
TENSION: [V]			380V [Three-phase]	MP LIFTS	

07-HEADROOM

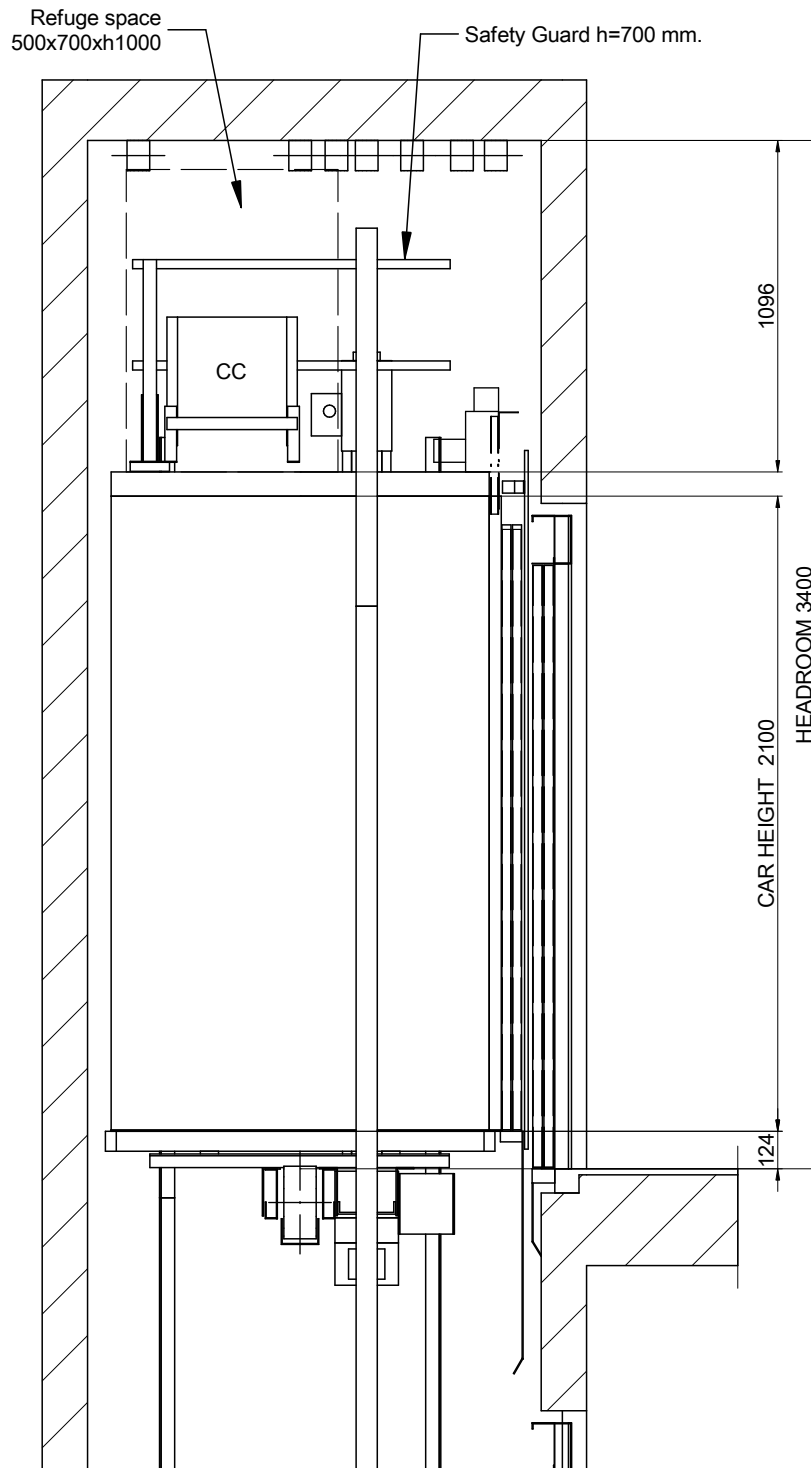

SCALE[*]: 1:25

DRAWING	DATE	REV.	SHEET	[*] Unbounded dimensions in drawings are indicative and not binding.	
MP	2017	00	8/8	REFERENCE: MPGO!EVOLUTION480ST2_EN	
MODEL LIFT:				CLIENT:	<h2>MP LIFTS</h2>
MP GO! EVOLUTION				WORK SITUATION:	
CAPACITY: [N° PERSONS]			6		
NOMINAL LOAD: [kg]			480		
SPEED: [m/s]			1		
FREQUENCY: [Hz]			50		
TENSION: [V]		380V [Three-phase]			