

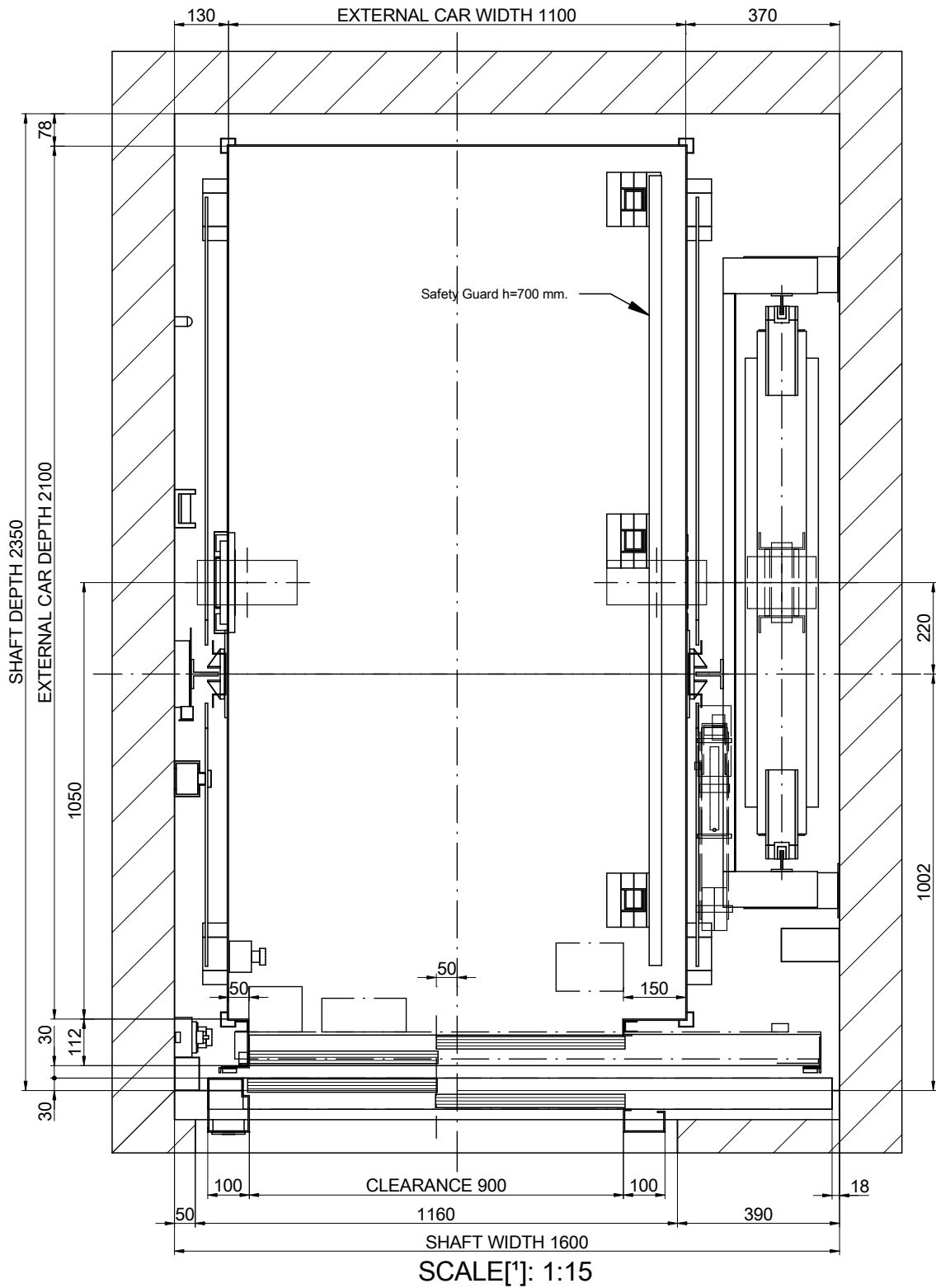

01-PLAN VIEW



DRAWING	DATE	REV.	SHEET	[*] Unbounded dimensions in drawings are indicative and not binding. REFERENCE: MPGO!EVOLUTION1000ST2_EN	
MP	2017	00	1/8		
MODEL LIFT:				CLIENT:	WORK SITUATION:
MP GO! EVOLUTION					
CAPACITY: [N° PERSONS]			13	<h2>MP LIFTS</h2>	
NOMINAL LOAD: [kg]			1000		
SPEED: [m/s]			1		
FREQUENCY: [Hz]			50		
TENSION: [V]			380V [Three-phase]		

01B-PLAN VIEW

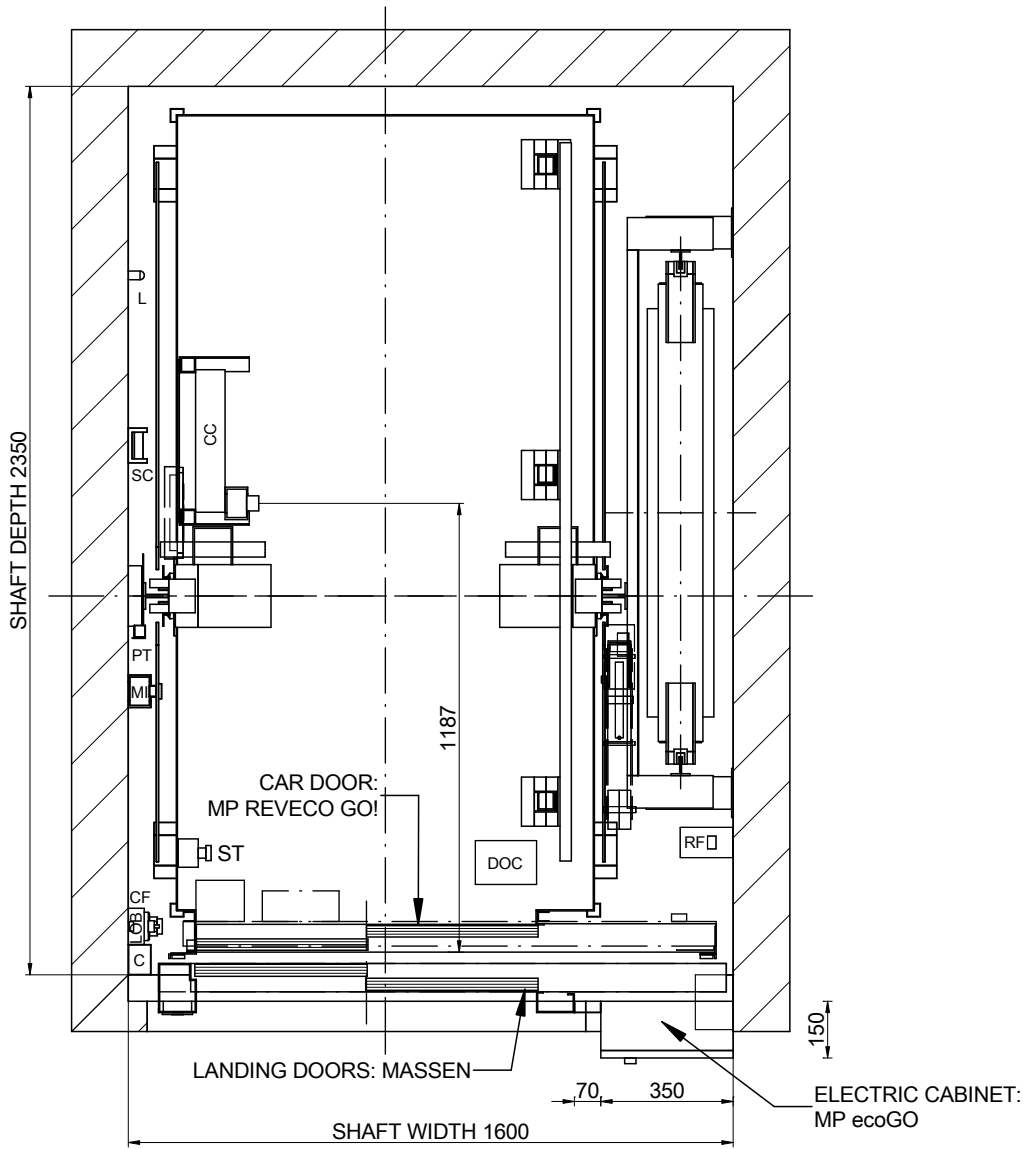

SCALE[*]: 1:20

OPTIONAL ELECTRIC CABINET:
Via Serie (385x230x2160)

NOMENCLATURE

- C: Wiring channel
- CC: Car ceiling connection box
- CF: Pit box
- CL: Shaft light switch
- DOC: Operator control box
- L: Lamp
- LOB: Pushbutton control board
- MI: Inspection control station
- PT: Fixed cam
- RF: Brake resistor
- ST: Stopping device
- SC: Travelling cable support

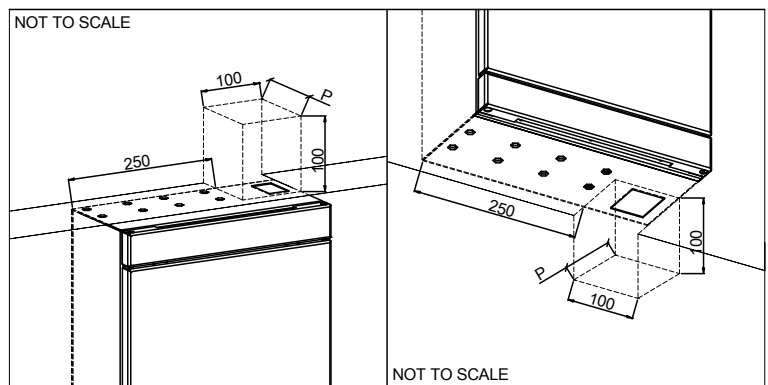

DRAWING	DATE	REV.	SHEET
MP	2017	00	2/8
MODEL LIFT:			
MP GO! EVOLUTION			
CAPACITY: [N° PERSONS]		13	
NOMINAL LOAD: [kg]		1000	
SPEED: [m/s]		1	
FREQUENCY: [Hz]		50	
TENSION: [V]		380V [Three-phase]	

[*] Unbounded dimensions in drawings are indicative and not binding.

REFERENCE:
MPGO!EVOLUTION1000ST2_EN

CLIENT:
WORK SITUATION:

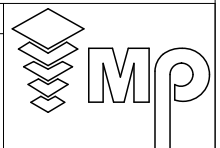

MP LIFTS

02-SIDE VERTICAL SECTION

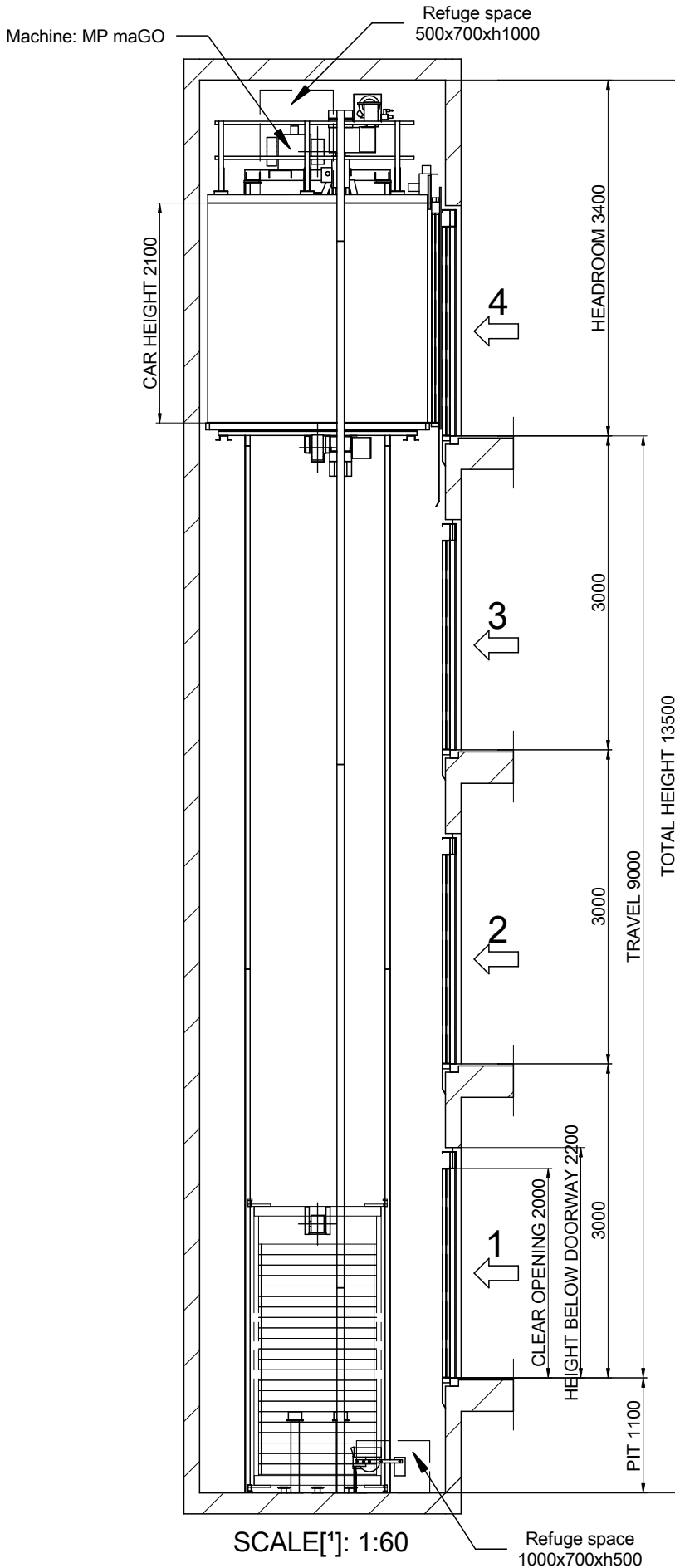

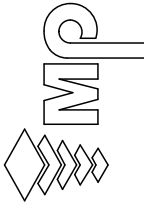
		[*] Unbounded dimensions in drawings are indicative and not binding.	
		DRAWING	SHEET
MP	REV. 00	DATE 2017	3/8
MODEL LIFT:		REFERENCE: MPGOIEVOLUTION1000ST2_EN	
MP GOI EVOLUTION		CLIENT: WORK SITUATION:	
CAPACITY: [N° PERSONS]	13		
NOMINAL LOAD: [kg]	1000		
SPEED: [m/s]	1		
FREQUENCY: [Hz]	50		
TENSION: [V]	380V [Three-phase]		

Flat and levelled floor, protected against water leaking.
 [EN81-20:2014 5.2.1.9]
 Foresee pit access device
 [EN81-20:2014 5.2.2.4]
 Stop device
 [EN81-20:2014 5.2.1.5.1. a]
 Inspection control station.
 [EN81-20:2014 5.2.1.5.1. b]
 Power supply
 [EN81-20:2014 5.2.1.5.1. c]
 Light switch
 commuted with the cabinet.
 [EN81-20:2014 5.2.1.5.1. d]

MP LIFTS

03B-FIXING DETAILS IN HEADROOM

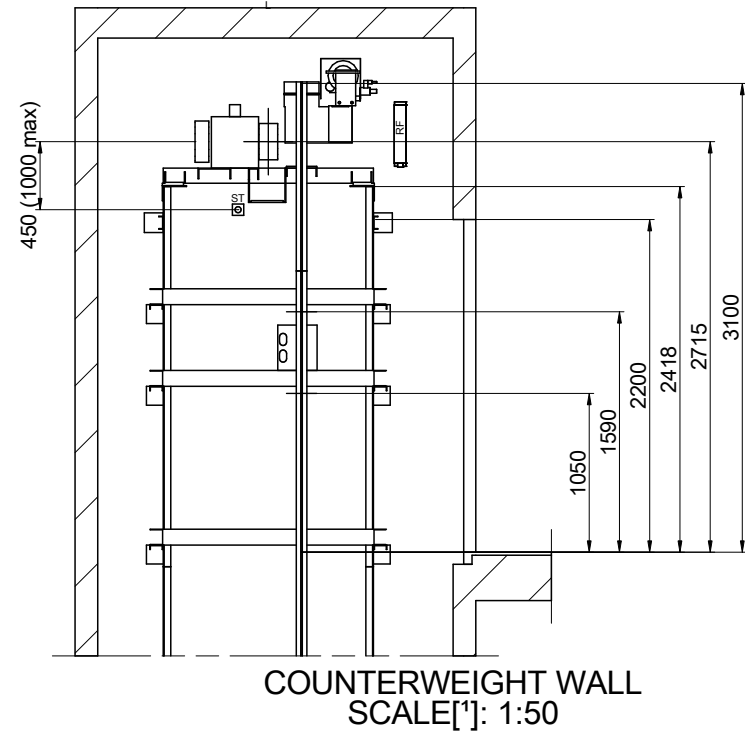
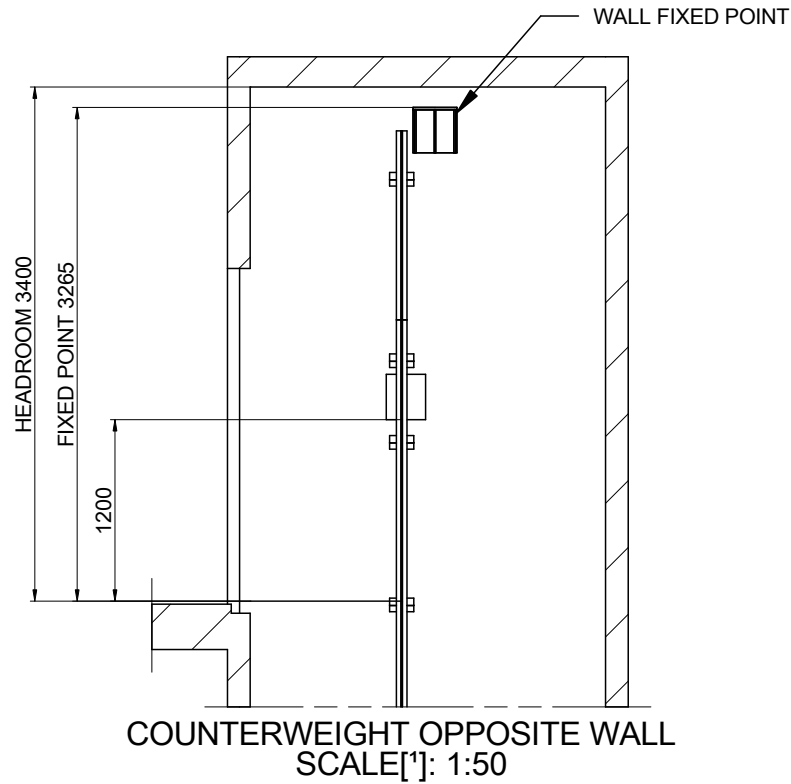

DRAWING	DATE	REV.	SHEET
MP	2017	00	4/8
MODEL LIFT:			
MP GO! EVOLUTION			
CAPACITY: [N° PERSONS]			13
NOMINAL LOAD: [kg]			1000
SPEED: [m/s]			1
FREQUENCY: [Hz]			50
TENSION: [V]		380V [Three-phase]	

[*] Unbounded dimensions in drawings are indicative and not binding.

REFERENCE:
MPGO!EVOLUTION1000ST2_EN

CLIENT:
WORK SITUATION:



MP LIFTS

04-BEAM AND LIFTING HOOKS

POSITION OF REMOVABLE LIFTING HOOKS ABLE TO SUPPORT
2000 kg EACH ONE SUPPLIED BY CONSTRUCTOR
(RECOMMENDED POSITION LOADHOOKS)

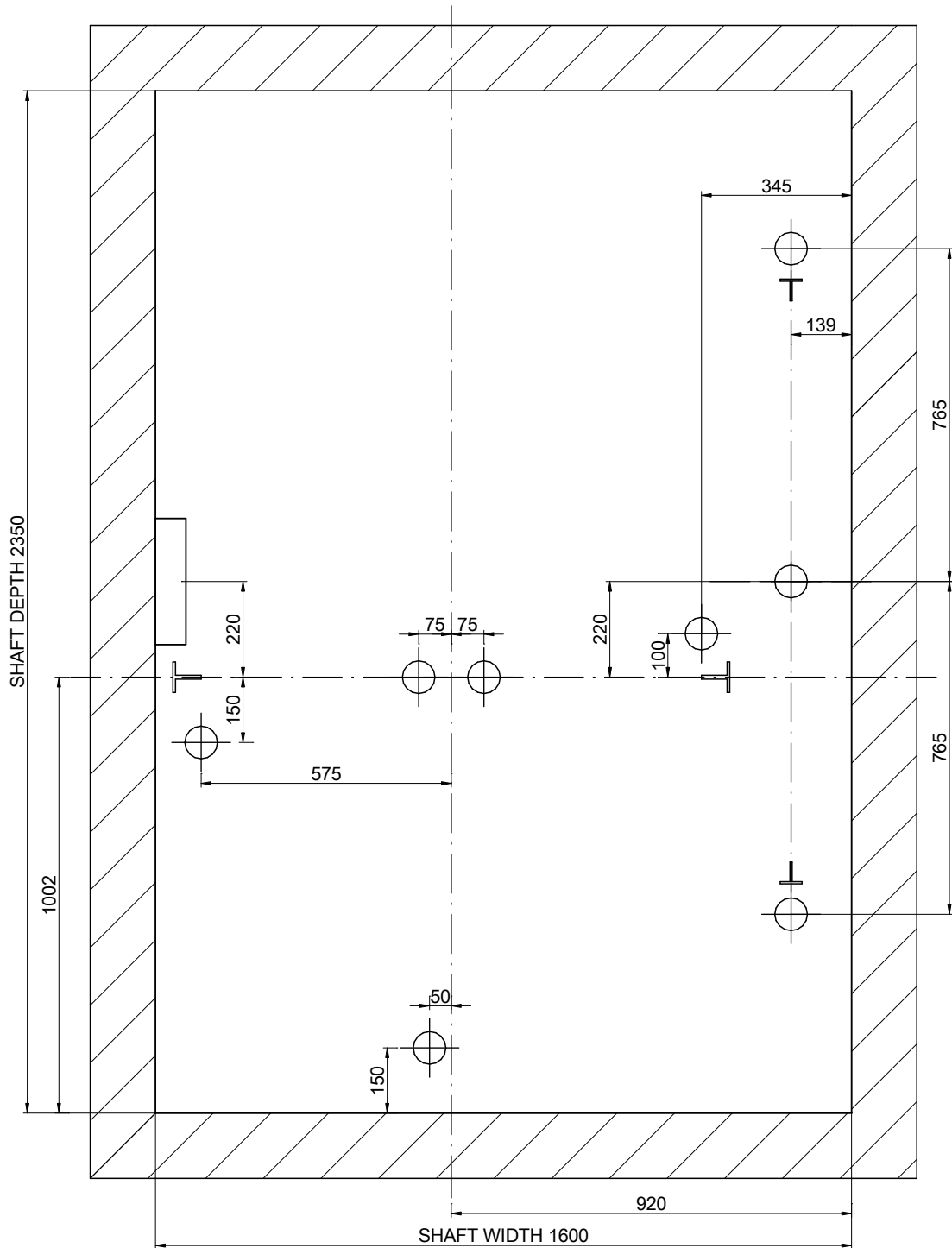

SCALE[*]: 1:15

DRAWING	DATE	REV.	SHEET	[*] Unbounded dimensions in drawings are indicative and not binding.	
MP	2017	00	5/8	REFERENCE: MPGO!EVOLUTION1000ST2_EN	
MODEL LIFT:				CLIENT:	<p>MP LIFTS</p>
MP GO! EVOLUTION				WORK SITUATION:	
CAPACITY: [N° PERSONS]			13		
NOMINAL LOAD: [kg]			1000		
SPEED: [m/s]			1		
FREQUENCY: [Hz]			50		
TENSION: [V]			380V [Three-phase]		

05-PIT LAYOUT

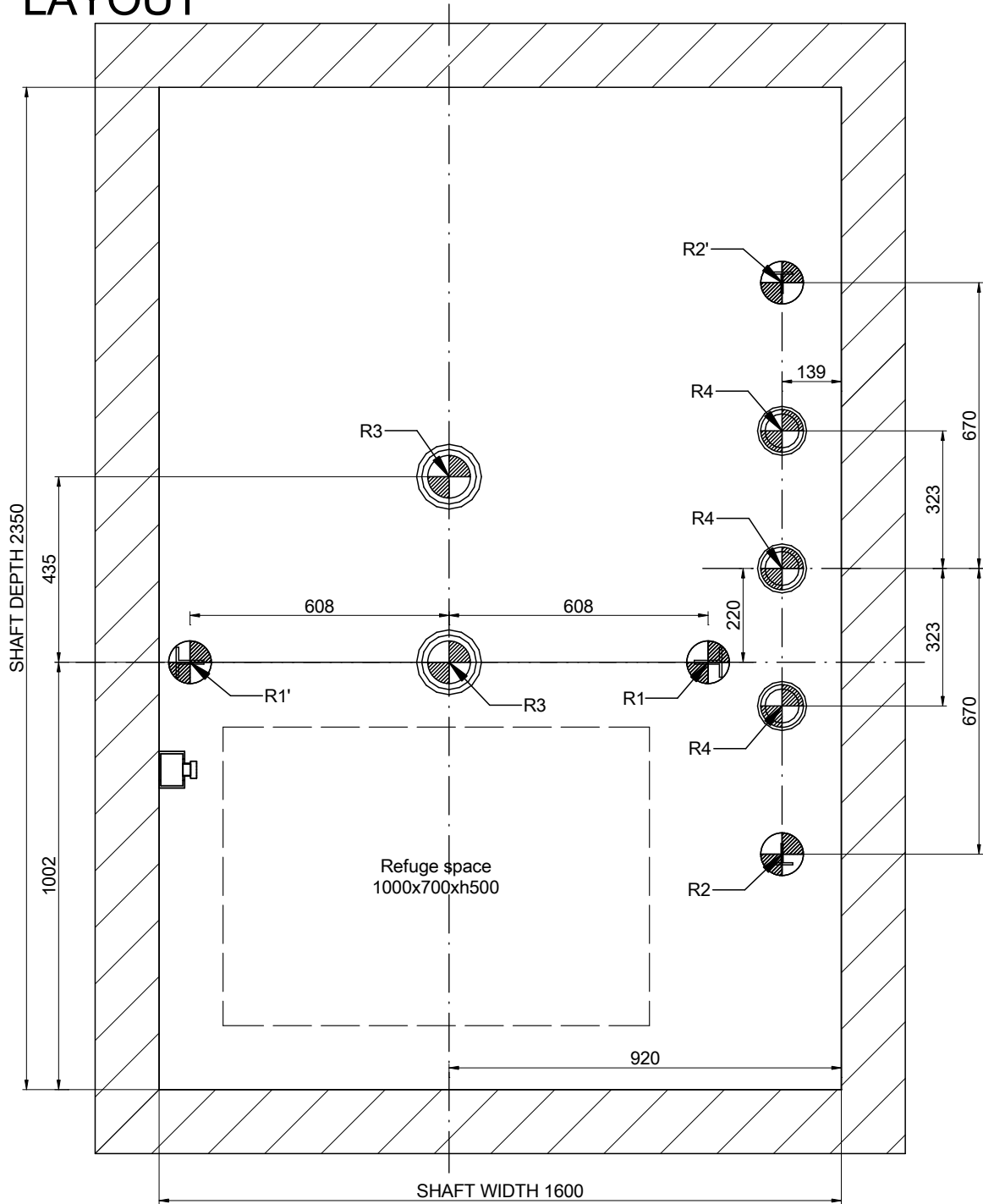

SCALE[*]: 1:15

REACTIONS [N] [max.]			
R1	23000	R2	22000
R1'	23000	R2'	23000
R3	38000	R4	18800
N	2700	T	1000

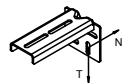

DRAWING	DATE	REV.	SHEET
MP	2017	00	6/8
MODEL LIFT:			
MP GO! EVOLUTION			
CAPACITY: [N° PERSONS]	13		
NOMINAL LOAD: [kg]	1000		
SPEED: [m/s]	1		
FREQUENCY: [Hz]	50		
TENSION: [V]	380V [Three-phase]		

[*] Unbounded dimensions in drawings are indicative and not binding.

REFERENCE:
MPGO!EVOLUTION1000ST2_EN



CLIENT:
WORK SITUATION:

MP LIFTS

06-DOOR HOLE DETAIL

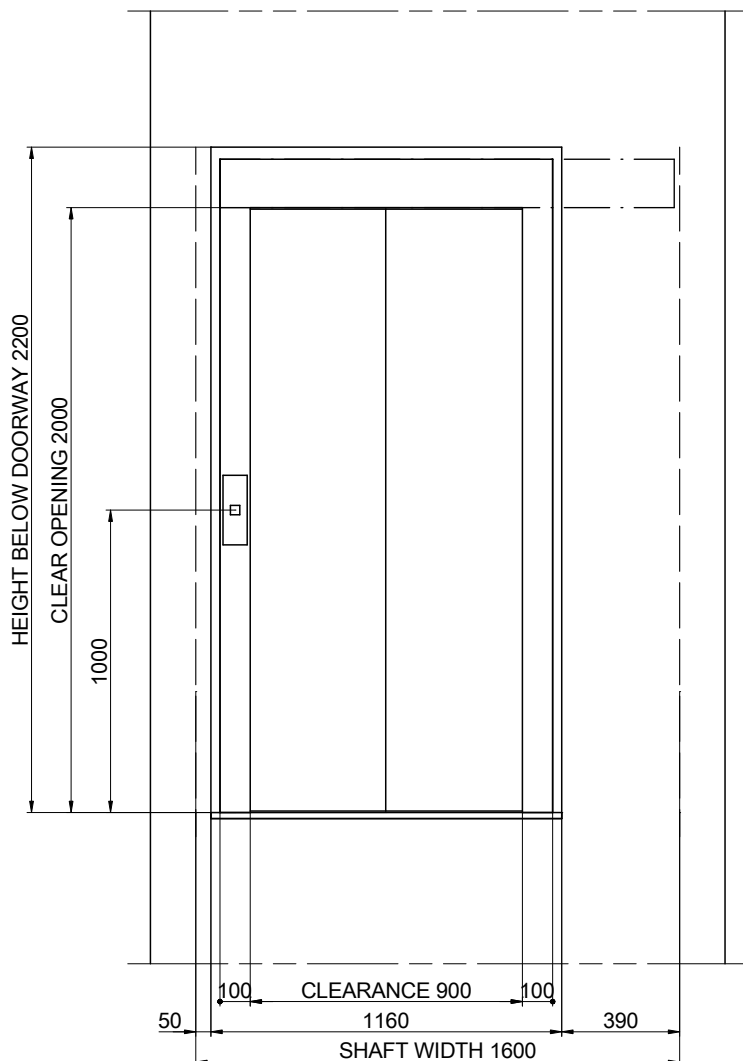

SCALE[*]: 1:25

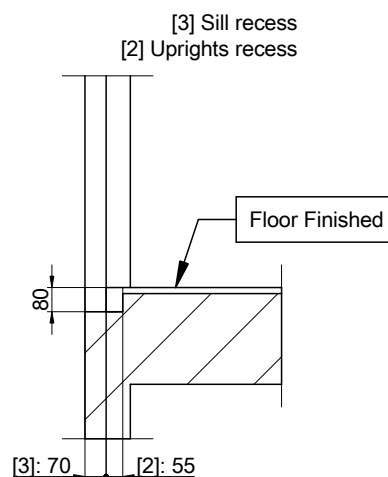

SCALE[*]: 1:25

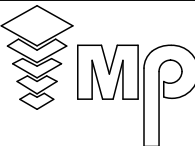
DRAWING	DATE	REV.	SHEET	[*] Unbounded dimensions in drawings are indicative and not binding.	
MP	2017	00	7/8	REFERENCE: MPGO!EVOLUTION1000ST2_EN	
MODEL LIFT:				CLIENT: WORK SITUATION:	
MP GO! EVOLUTION					
CAPACITY: [N° PERSONS]		13			
NOMINAL LOAD: [kg]		1000			
SPEED: [m/s]		1			
FREQUENCY: [Hz]		50			
TENSION: [V]		380V [Three-phase]		MP LIFTS	

07-HEADROOM

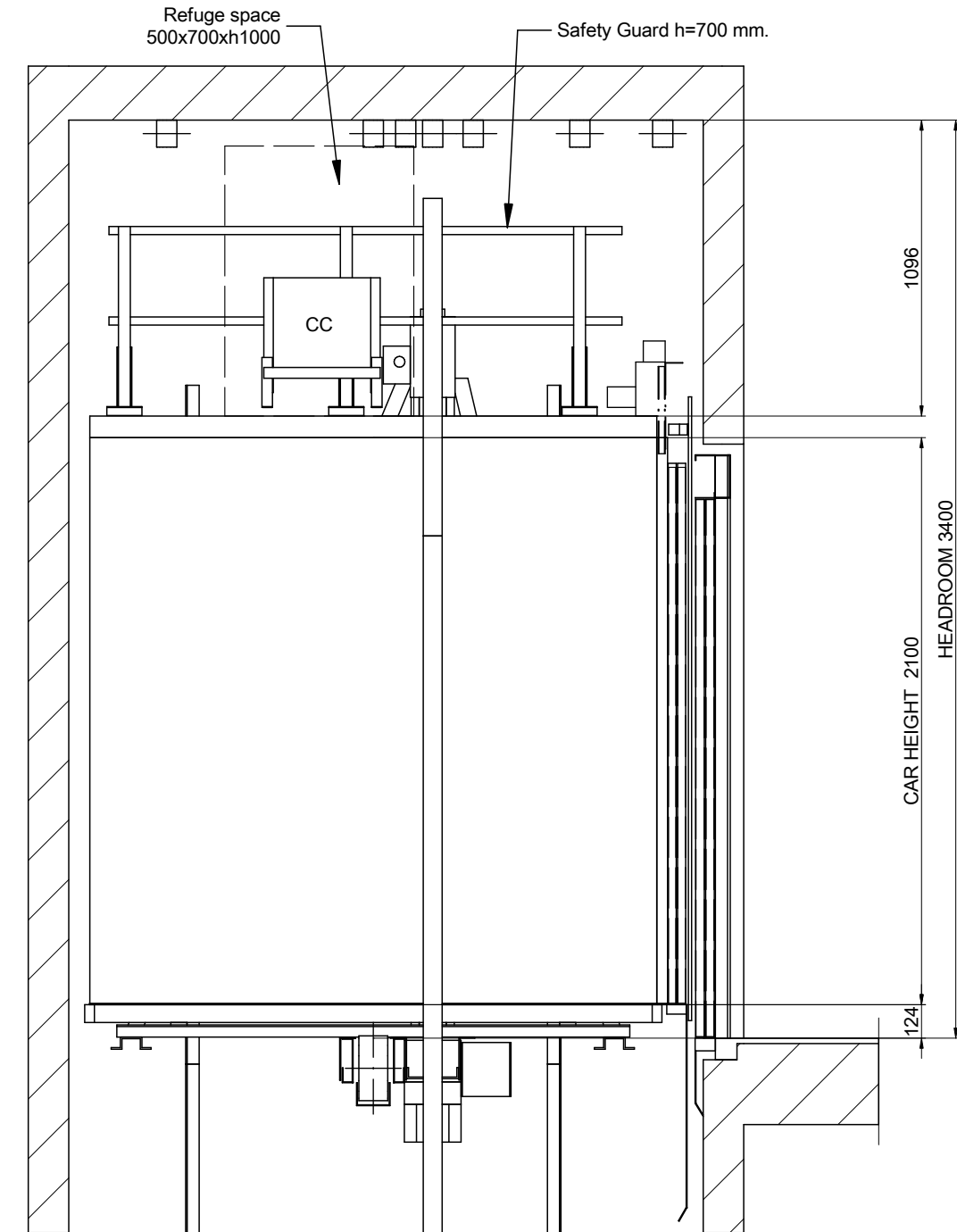

SCALE[*]: 1:25

DRAWING	DATE	REV.	SHEET	[*] Unbounded dimensions in drawings are indicative and not binding. REFERENCE: MPGO!EVOLUTION1000ST2_EN	
MP	2017	00	8/8		
MODEL LIFT:				CLIENT:	
MP GO! EVOLUTION					
CAPACITY: [N° PERSONS]		13		WORK SITUATION:	
NOMINAL LOAD: [kg]		1000			
SPEED: [m/s]		1			
FREQUENCY: [Hz]		50			
TENSION: [V]		380V [Three-phase]			
				MP LIFTS	