

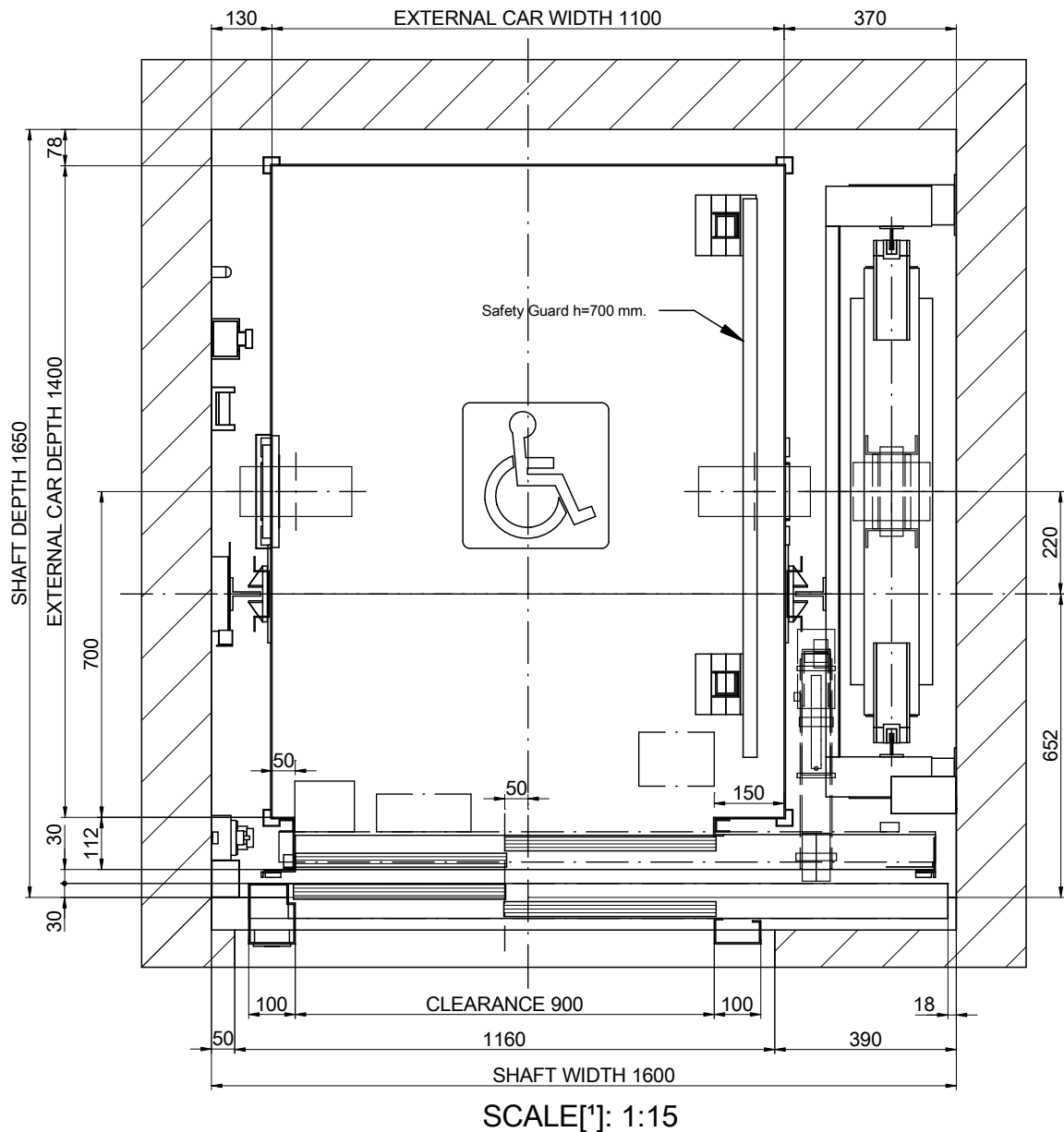

01-PLAN VIEW



DRAWING	DATE	REV.	SHEET	[*] Unbounded dimensions in drawings are indicative and not binding.	
MP	2017	00	1/8	REFERENCE: MPGO!EVOLUTION630ST2_EN	
MODEL LIFT:				CLIENT:	MP LIFTS
MP GO! EVOLUTION				WORK SITUATION:	
CAPACITY: [N° PERSONS]			8		
NOMINAL LOAD: [kg]			630		
SPEED: [m/s]			1		
FREQUENCY: [Hz]			50		
TENSION: [V]		380V [Three-phase]			

01B-PLAN VIEW

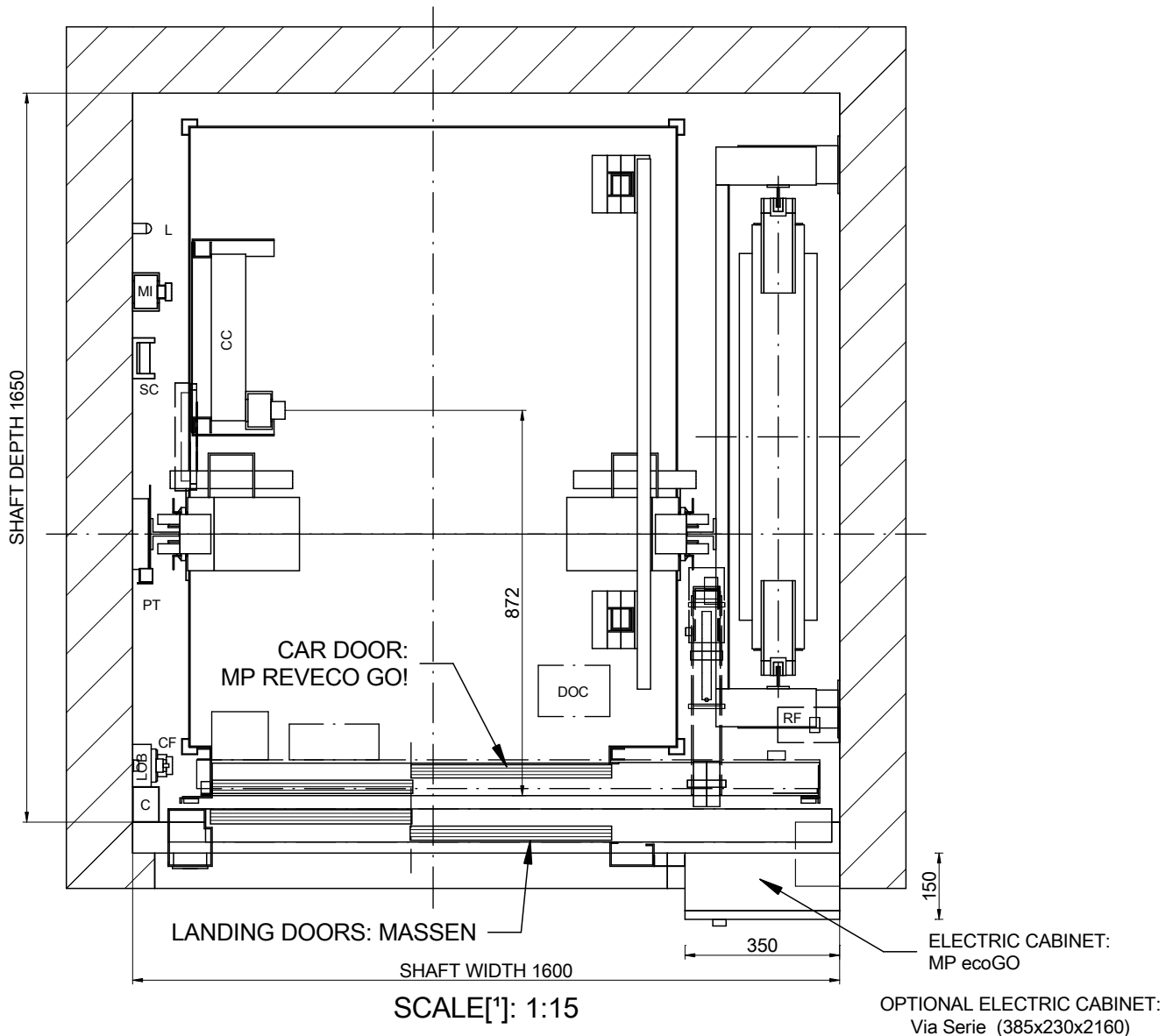

NOMENCLATURE

- C: Wiring channel
- CC: Car ceiling connection box
- CF: Pit box
- CL: Shaft light switch
- DOC: Operator control box
- L: Lamp
- LOB: Pushbutton control board
- MI: Inspection control station
- PT: Fixed cam
- RF: Brake resistor
- ST: Stopping device
- SC: Travelling cable support

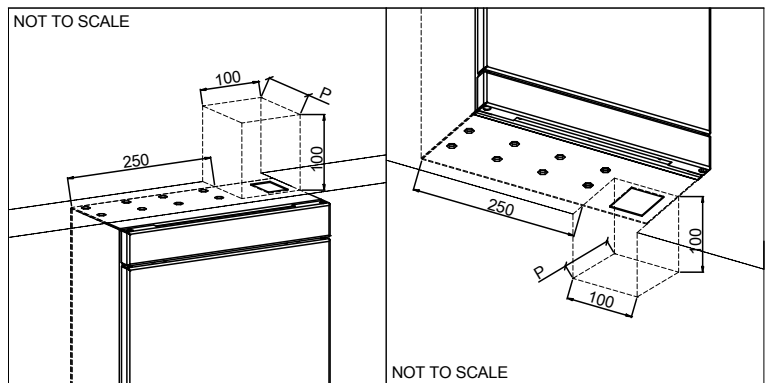

DRAWING	DATE	REV.	SHEET
MP	2017	00	2/8
MODEL LIFT:			
MP GO! EVOLUTION			
CAPACITY: [N° PERSONS]			8
NOMINAL LOAD: [kg]			630
SPEED: [m/s]			1
FREQUENCY: [Hz]			50
TENSION: [V]		380V [Three-phase]	

[*] Unbounded dimensions in drawings are indicative and not binding.

REFERENCE:
MPGO!EVOLUTION630ST2_EN

CLIENT:
WORK SITUATION:

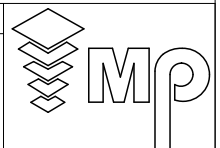

MP LIFTS

02-SIDE VERTICAL SECTION

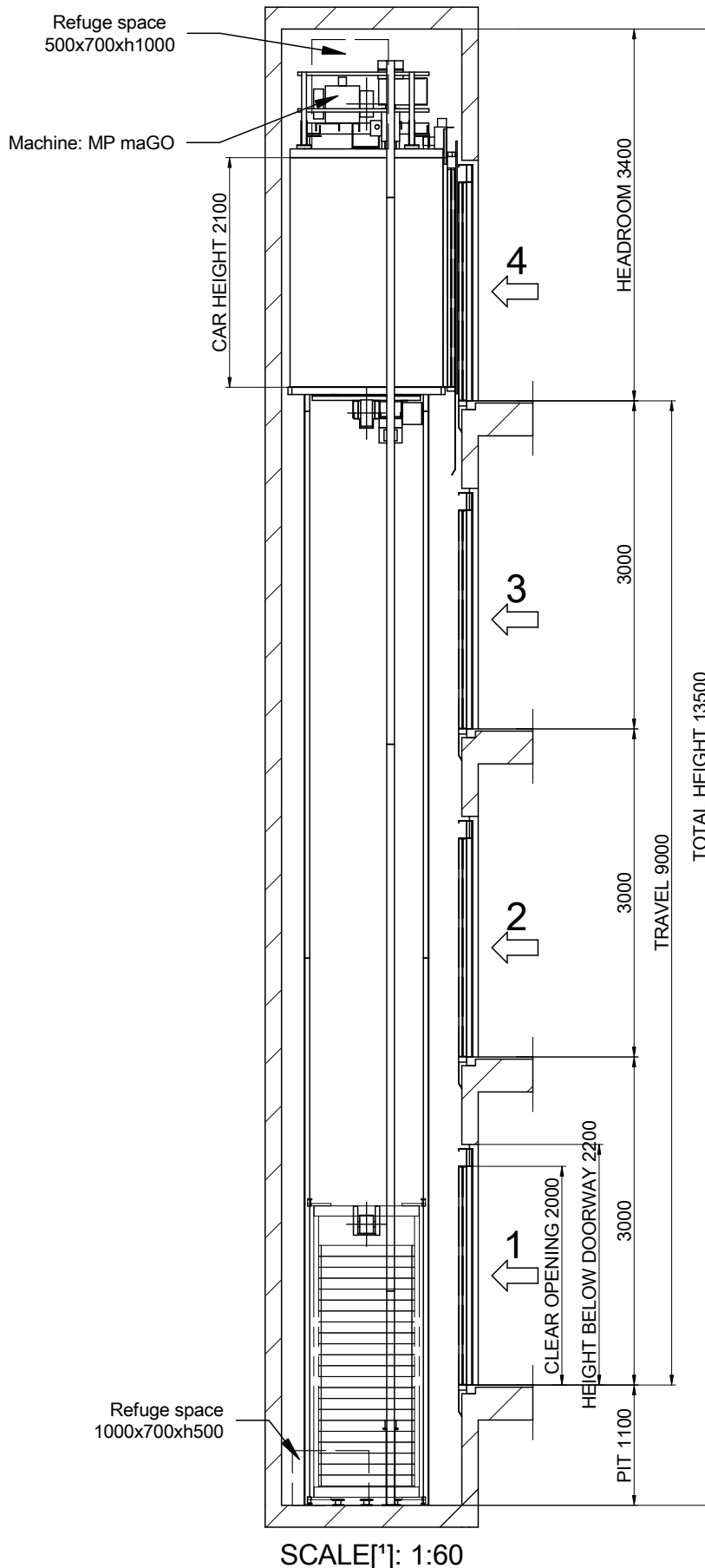

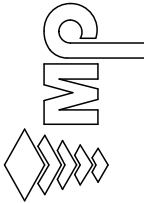
		[*] Unbounded dimensions in drawings are indicative and not binding.	
		DRAWING	SHEET
MP	REV. 00	DATE 2017	SHEET 3/8
MODEL LIFT:		REFERENCE: MPGOIEVOLUTION630ST2_EN	
MP GOI EVOLUTION		CLIENT: WORK SITUATION:	
CAPACITY: [N° PERSONS] 8			
NOMINAL LOAD: [kg] 630			
SPEED: [m/s] 1			
FREQUENCY: [Hz] 50			
TENSION: [V] 380V [Three-phase]			
			MP LIFTS

Flat and levelled floor, protected against water leaking.
 [EN81-20:2014 5.2.1.9]
 Foresee pit access device
 [EN81-20:2014 5.2.2.4]
 Stop device
 [EN81-20:2014 5.2.1.5.1. a]
 Inspection control station.
 [EN81-20:2014 5.2.1.5.1. b]
 Power supply
 [EN81-20:2014 5.2.1.5.1. c]
 Light switch commuted with the cabinet.
 [EN81-20:2014 5.2.1.5.1. d]

03B-FIXING DETAILS IN HEADROOM

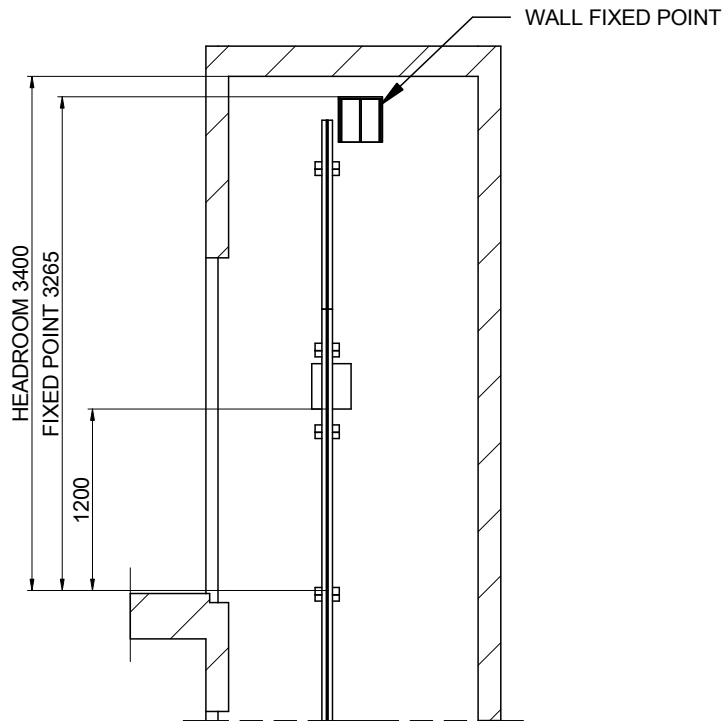

COUNTERWEIGHT OPPOSITE WALL
SCALE[*]: 1:50

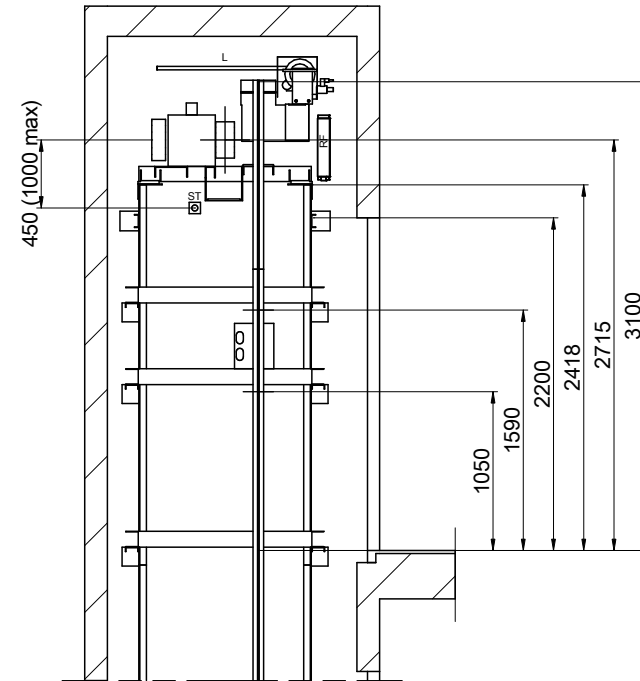

COUNTERWEIGHT WALL
SCALE[*]: 1:50

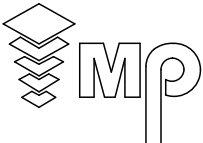
DRAWING	DATE	REV.	SHEET	[*] Unbounded dimensions in drawings are indicative and not binding.	
MP	2017	00	4/8		
MODEL LIFT:				REFERENCE: MPGO!EVOLUTION630ST2_EN	
MP GO! EVOLUTION				CLIENT:	
CAPACITY: [N° PERSONS]			8	WORK SITUATION:	
NOMINAL LOAD: [kg]			630		
SPEED: [m/s]			1		
FREQUENCY: [Hz]			50		
TENSION: [V]			380V [Three-phase]	MP LIFTS	

04-BEAM AND LIFTING HOOKS

POSITION OF REMOVABLE LIFTING HOOKS ABLE TO SUPPORT
1000 kg EACH ONE SUPPLIED BY CONSTRUCTOR
(RECOMMENDED POSITION LOADHOOKS)

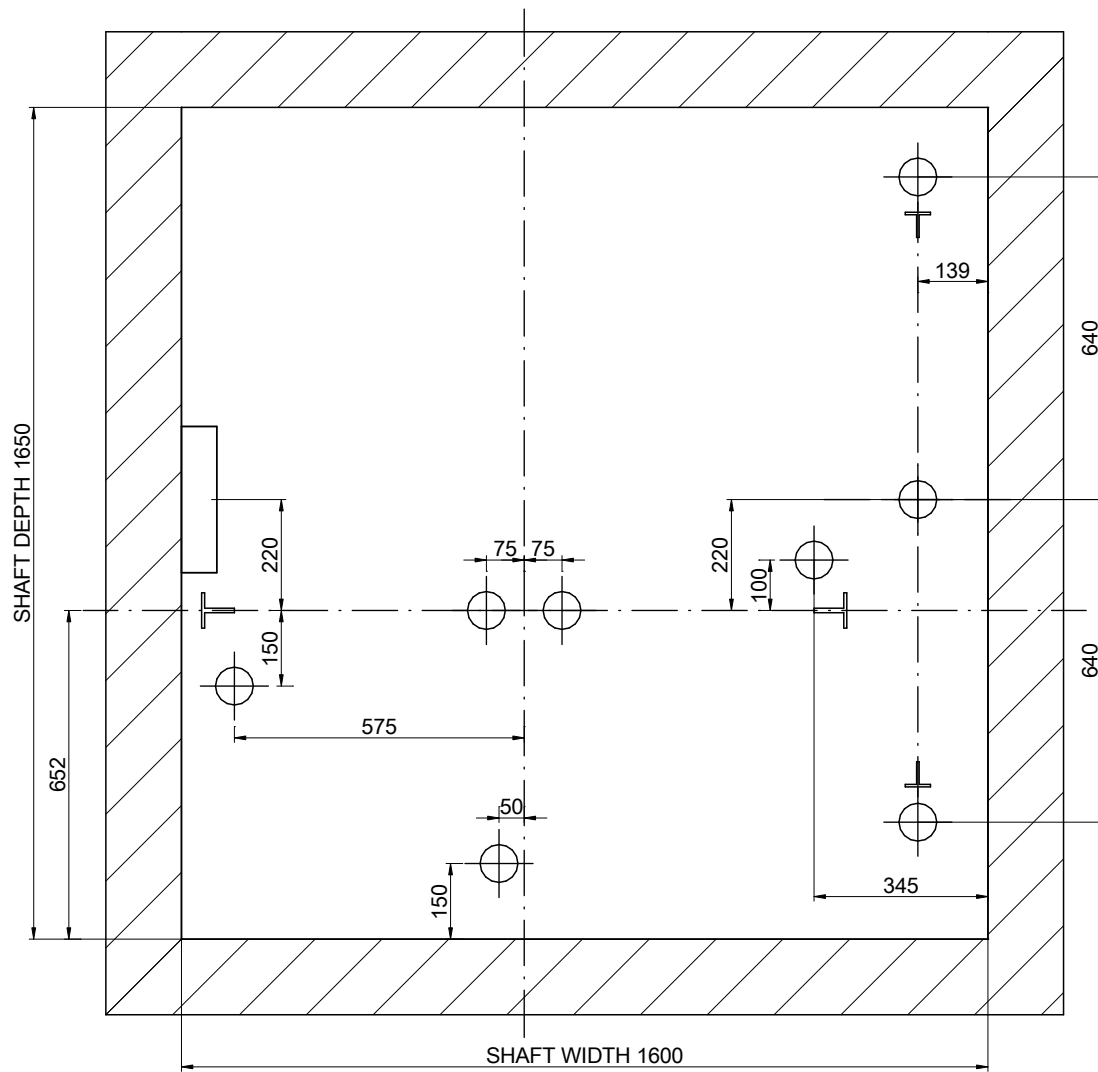

SCALE[*]: 1:15

DRAWING	DATE	REV.	SHEET	[*] Unbounded dimensions in drawings are indicative and not binding.	
MP	2017	00	5/8		
MODEL LIFT:				REFERENCE:	
MP GO! EVOLUTION				MPGO!EVOLUTION630ST2_EN	
CAPACITY: [N° PERSONS]				CLIENT:	<p>MP LIFTS</p>
NOMINAL LOAD: [kg]				WORK SITUATION:	
SPEED: [m/s]					
FREQUENCY: [Hz]					
TENSION: [V]					
380V [Three-phase]					

05-PIT LAYOUT

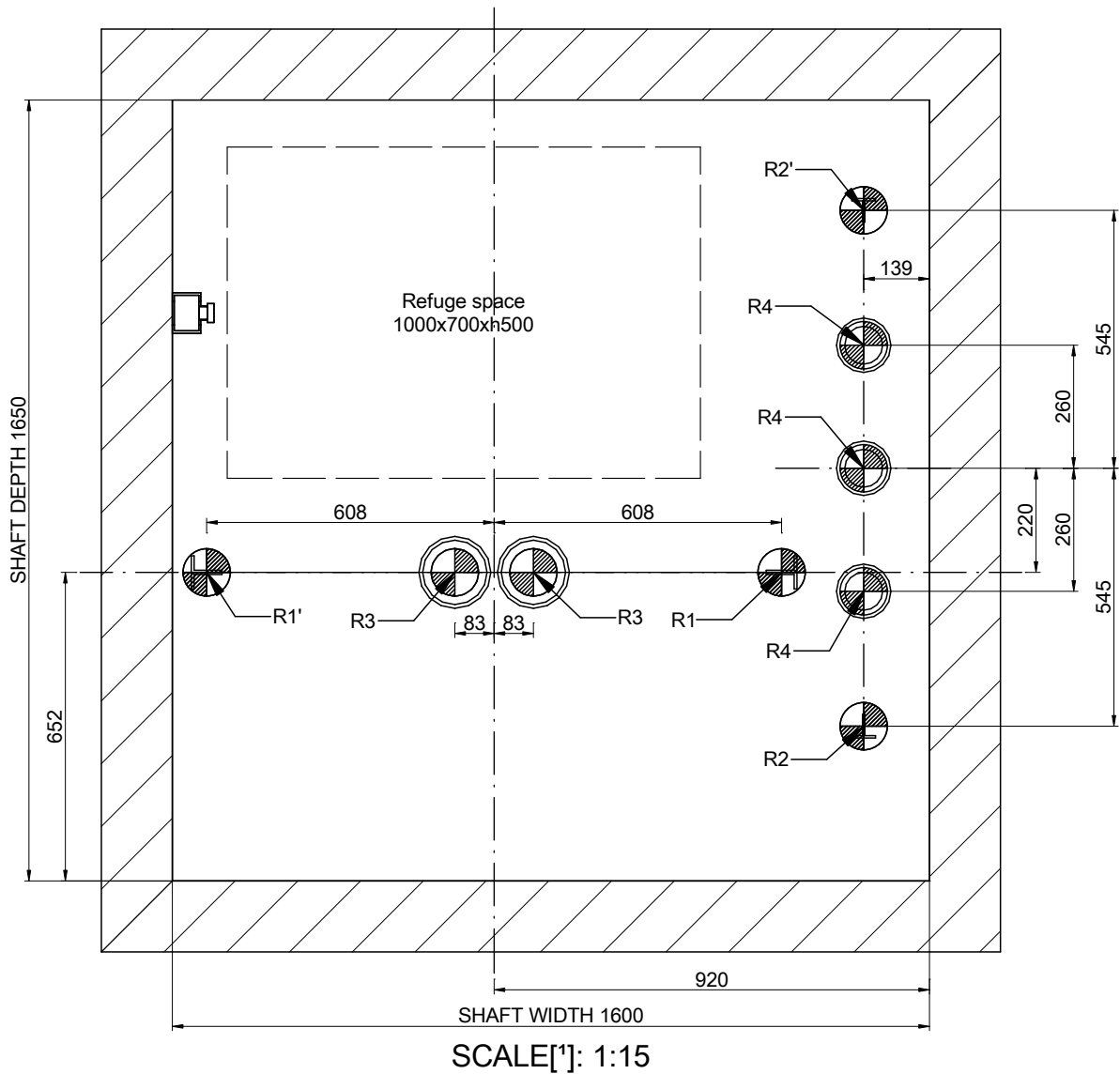

REACTIONS [N] [max.]			
R1	30000	R2	22000
R1'	26000	R2'	23000
R3	31500	R4	17000
N	2000	T	1100

DRAWING	DATE	REV.	SHEET	[*] Unbounded dimensions in drawings are indicative and not binding.	
MP	2017	00	6/8	REFERENCE: MPGO!EVOLUTION630ST2_EN	
MODEL LIFT:				CLIENT:	MP LIFTS
MP GO! EVOLUTION				WORK SITUATION:	
CAPACITY: [N° PERSONS]			8		
NOMINAL LOAD: [kg]			630		
SPEED: [m/s]			1		
FREQUENCY: [Hz]			50		
TENSION: [V]			380V [Three-phase]		

06-DOOR HOLE DETAIL

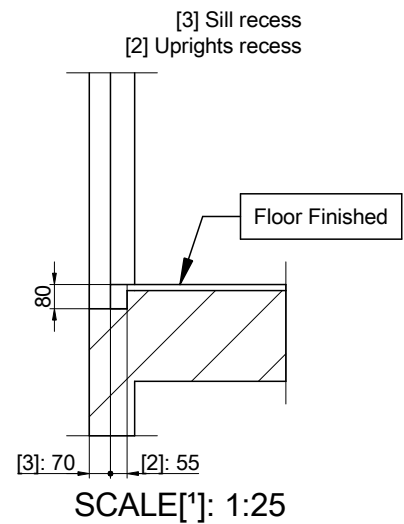
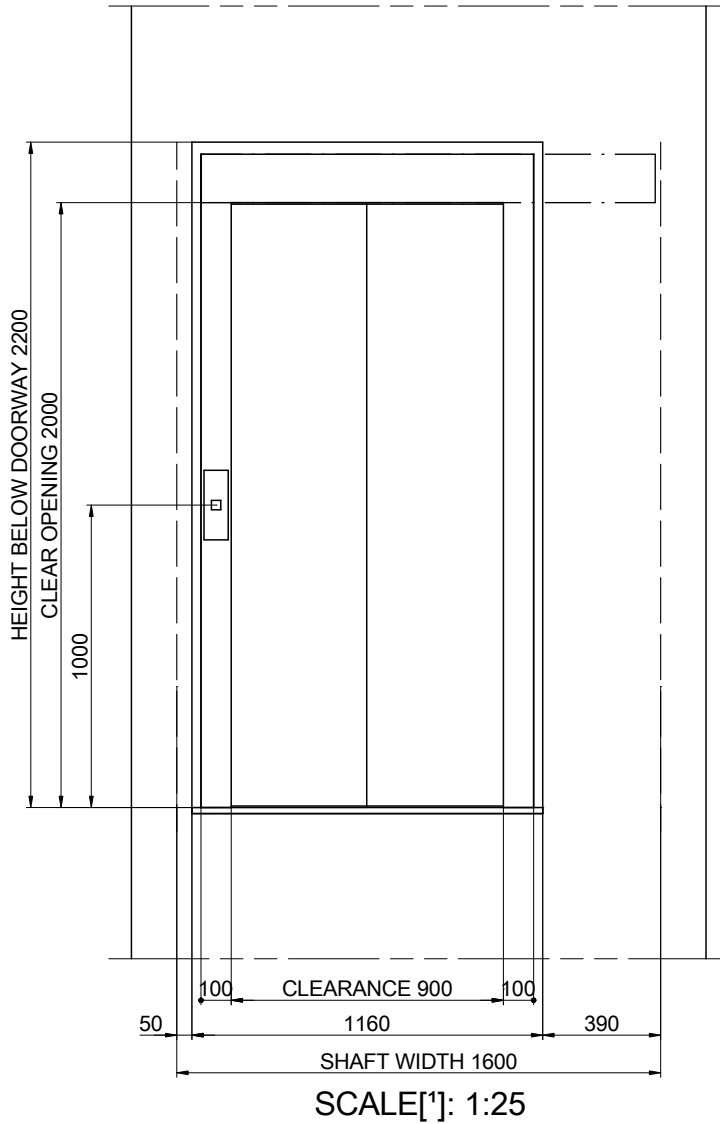

DRAWING	DATE	REV.	SHEET	[*] Unbounded dimensions in drawings are indicative and not binding.	
MP	2017	00	7/8	REFERENCE: MPGO!EVOLUTION630ST2_EN	
MODEL LIFT:				CLIENT: WORK SITUATION:	
MP GO! EVOLUTION					
CAPACITY: [N° PERSONS]			8		
NOMINAL LOAD: [kg]			630		
SPEED: [m/s]			1		
FREQUENCY: [Hz]			50		
TENSION: [V]			380V [Three-phase]	MP LIFTS	

07-HEADROOM

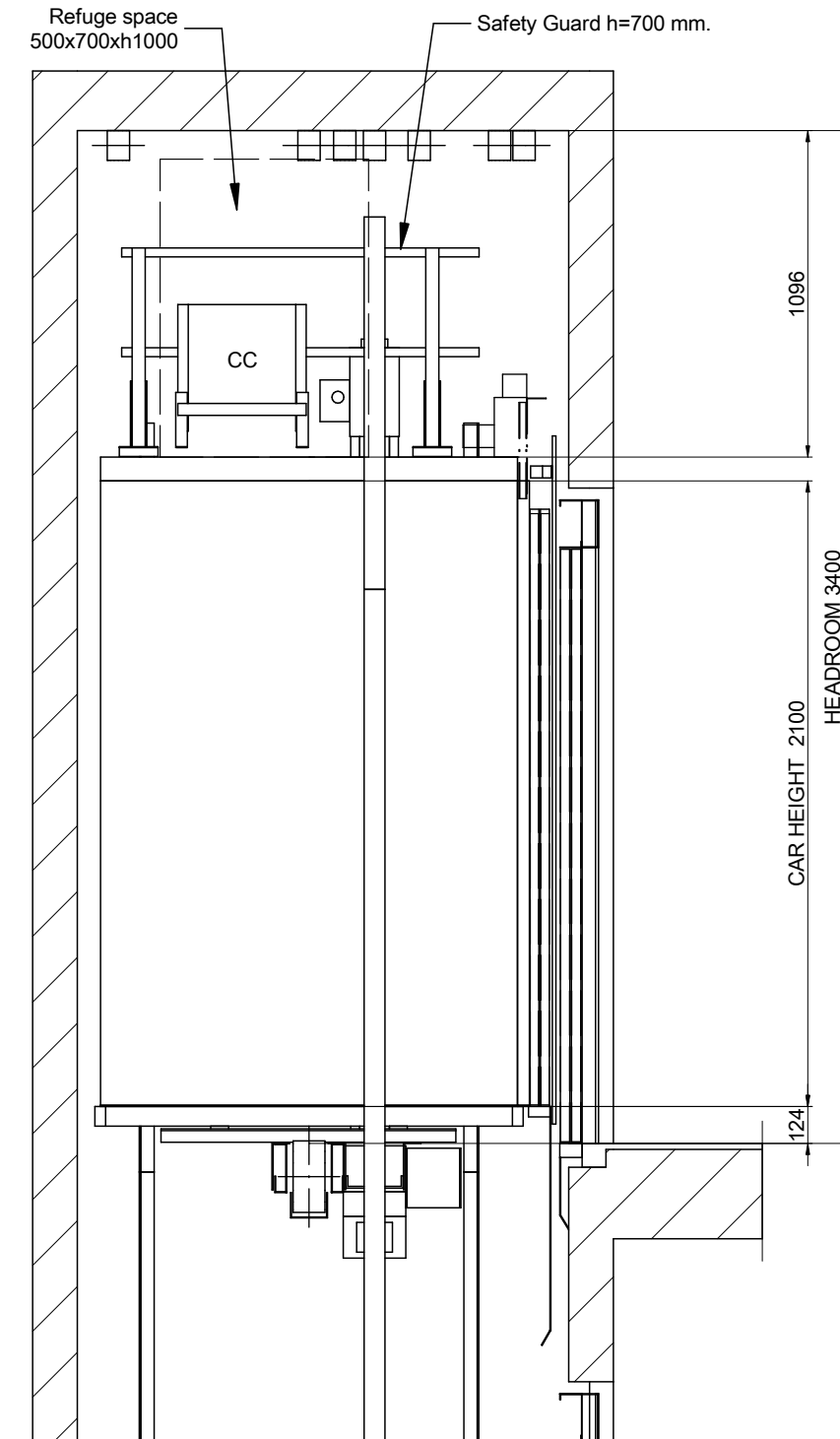

SCALE[*]: 1:25

DRAWING	DATE	REV.	SHEET	[*] Unbounded dimensions in drawings are indicative and not binding.	
MP	2017	00	8/8		
MODEL LIFT:				REFERENCE:	
MP GO! EVOLUTION				MPGO!EVOLUTION630ST2_EN	
CAPACITY: [N° PERSONS]				CLIENT:	
8				WORK SITUATION:	
NOMINAL LOAD: [kg]					
630					
SPEED: [m/s]					
1					
FREQUENCY: [Hz]					
50					
TENSION: [V]					
380V [Three-phase]					
MP LIFTS					