

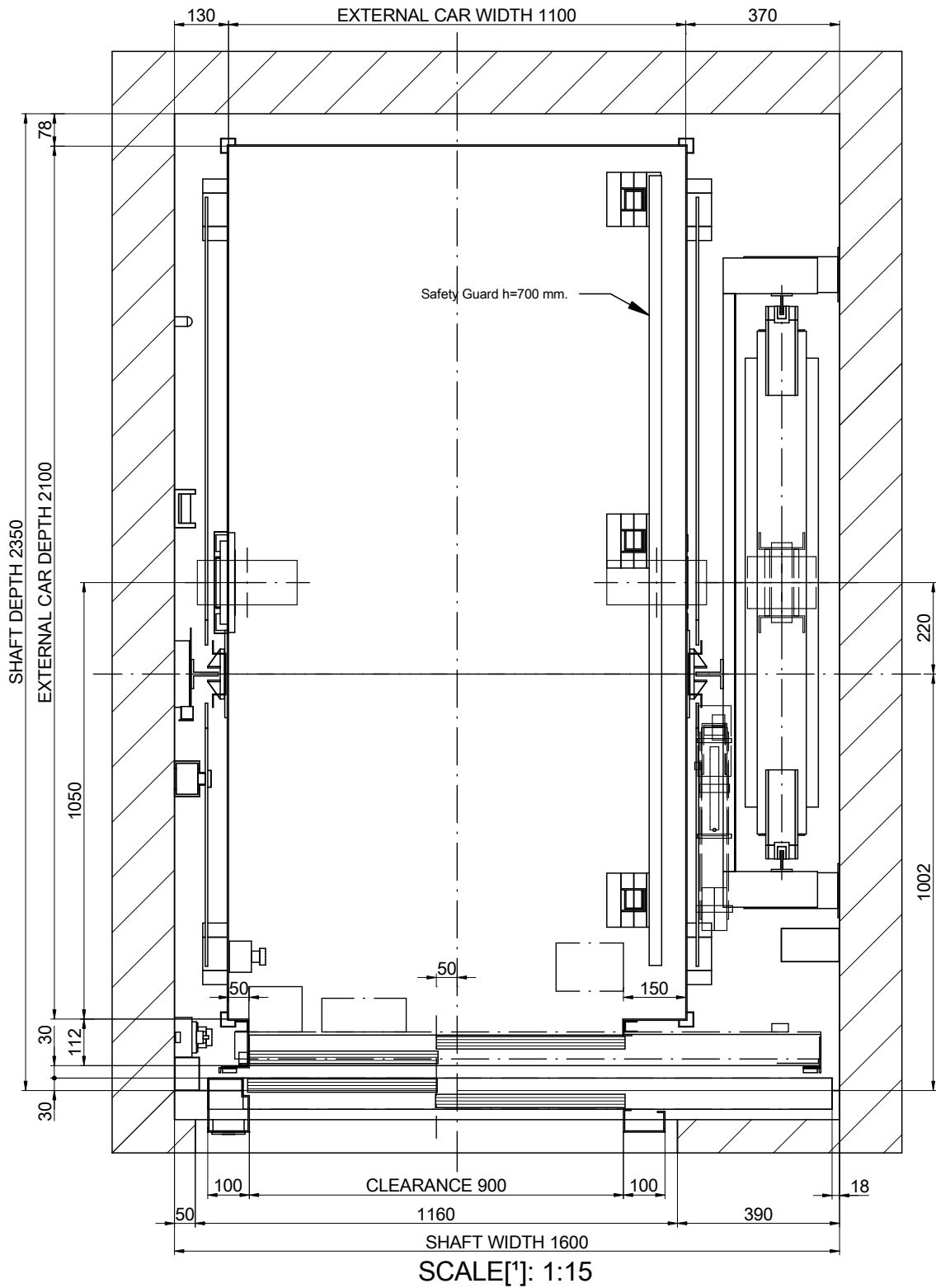

# 01-PLAN VIEW



DRAWING	DATE	REV.	SHEET	[*] Unbounded dimensions in drawings are indicative and not binding. REFERENCE: MPGO!EVOLUTION1000ST2_EN	
MP	2017	00	1/8		
MODEL LIFT:				CLIENT:	WORK SITUATION:
MP GO! EVOLUTION					
CAPACITY: [N° PERSONS]		13		<h2>MP LIFTS</h2>	
NOMINAL LOAD: [kg]		1000			
SPEED: [m/s]		1			
FREQUENCY: [Hz]		50			
TENSION: [V]		380V [Three-phase]			

# 01B-PLAN VIEW

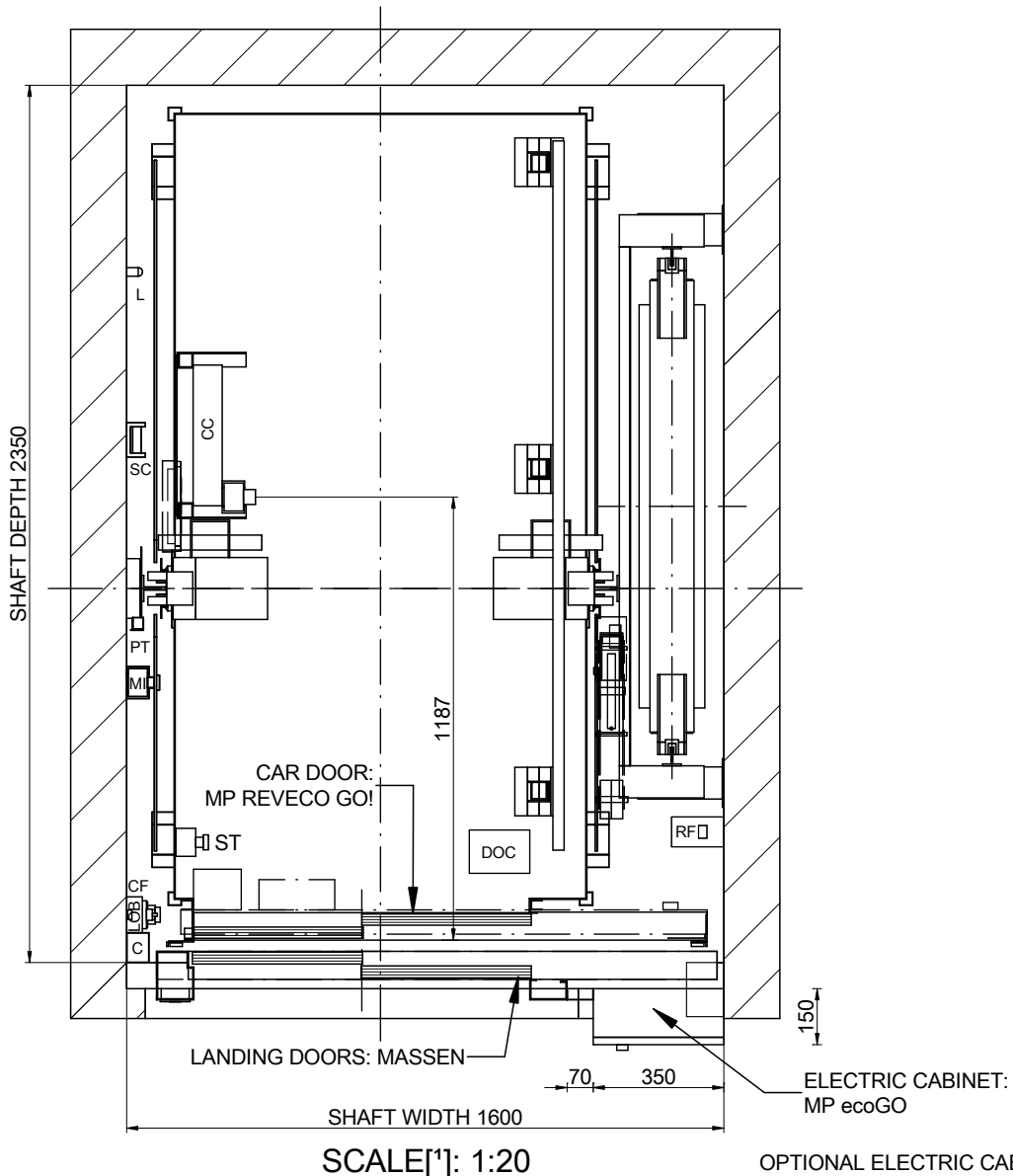

SCALE[\*]: 1:20

OPTIONAL ELECTRIC CABINET:  
Via Serie (385x230x2160)

## NOMENCLATURE

- C: Wiring channel
- CC: Car ceiling connection box
- CF: Pit box
- CL: Shaft light switch
- DOC: Operator control box
- L: Lamp
- LOB: Pushbutton control board
- MI: Inspection control station
- PT: Fixed cam
- RF: Brake resistor
- ST: Stopping device
- SC: Travelling cable support

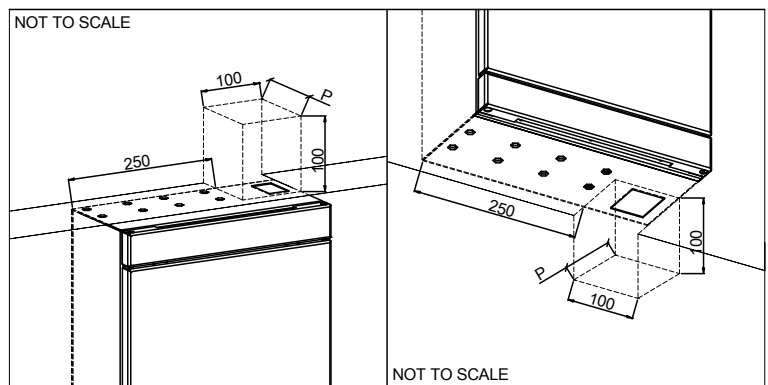

DRAWING	DATE	REV.	SHEET
MP	2017	00	2/8
MODEL LIFT:			
<b>MP GO! EVOLUTION</b>			
CAPACITY: [N° PERSONS]			13
NOMINAL LOAD: [kg]			1000
SPEED: [m/s]			1
FREQUENCY: [Hz]			50
TENSION: [V]			380V [Three-phase]

[\*] Unbounded dimensions in drawings are indicative and not binding.

REFERENCE:  
MPGO!EVOLUTION1000ST2\_EN

CLIENT:  
WORK SITUATION:

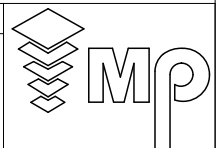

**MP LIFTS**

# 02-SIDE VERTICAL SECTION

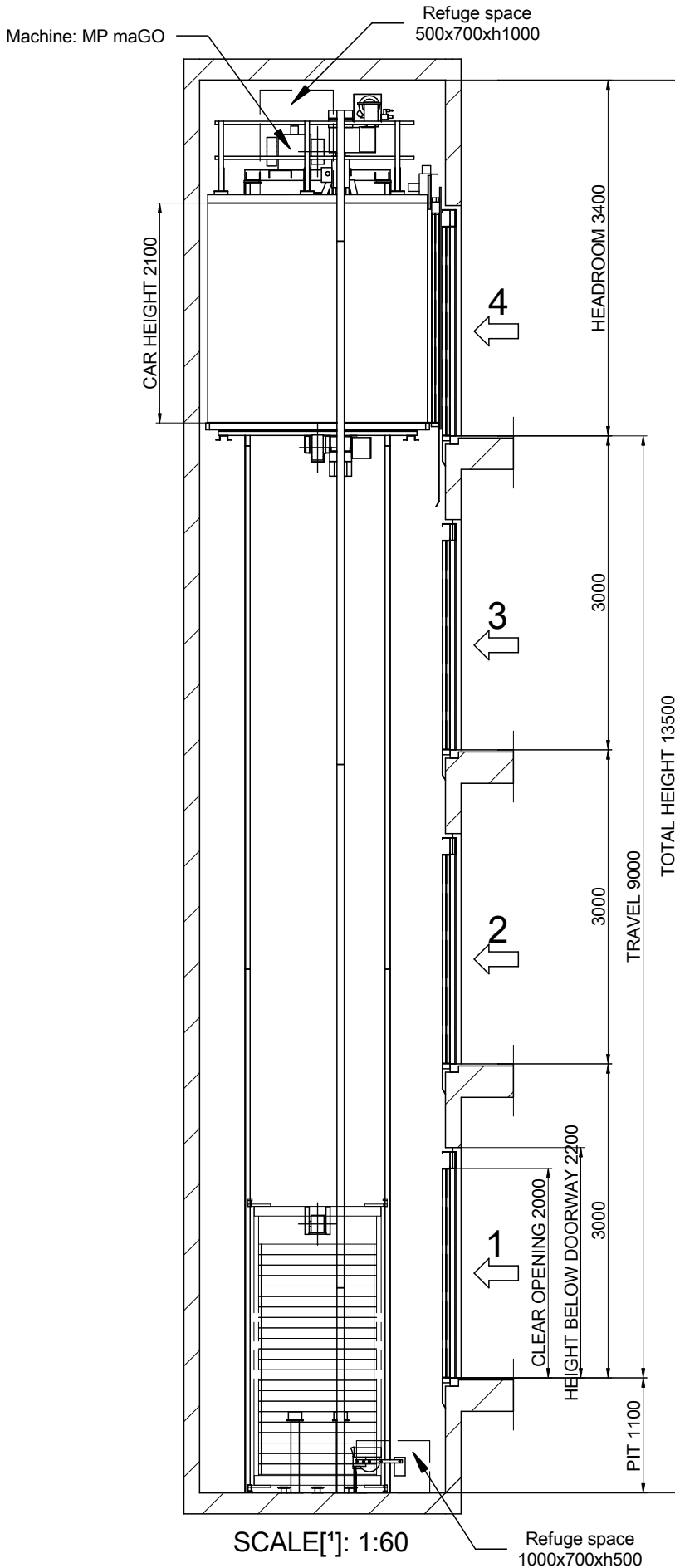

DRAWING		DATE	REV.	SHEET	[1] Unbounded dimensions in drawings are indicative and not binding. REFERENCE: MPGOIEVOLUTION1000ST2_EN
MP	2017	00	3/8		
MODEL LIFT:		MP GOI EVOLUTION			
CAPACITY: [N° PERSONS]		13			
NOMINAL LOAD: [kg]		1000			
SPEED: [m/s]		1			
FREQUENCY: [Hz]		50			
TENSION: [V]		380V [Three-phase]			
CLIENT: WORK SITUATION:					MP LIFTS

Flat and levelled floor, protected against water leaking.  
 [EN81-20:2014 5.2.1.9]  
 Foresee pit access device  
 [EN81-20:2014 5.2.2.4]  
 Stop device  
 [EN81-20:2014 5.2.1.5.1. a)  
 Inspection control station.  
 [EN81-20:2014 5.2.1.5.1. b)  
 Power supply  
 [EN81-20:2014 5.2.1.5.1. c)  
 Light switch  
 commuted with the cabinet.  
 [EN81-20:2014 5.2.1.5.1. d)

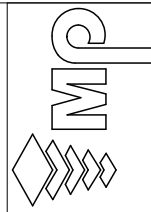

# 03B-FIXING DETAILS IN HEADROOM

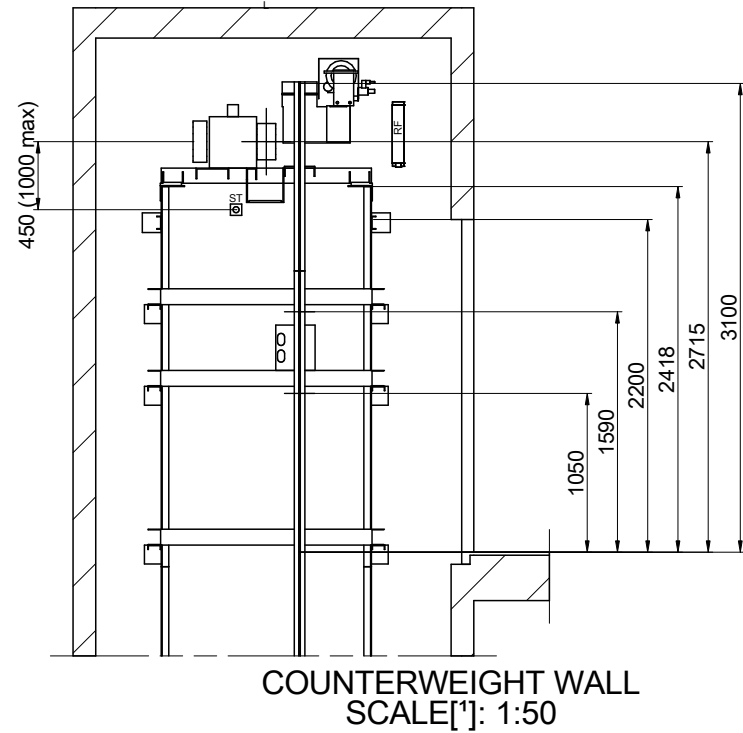
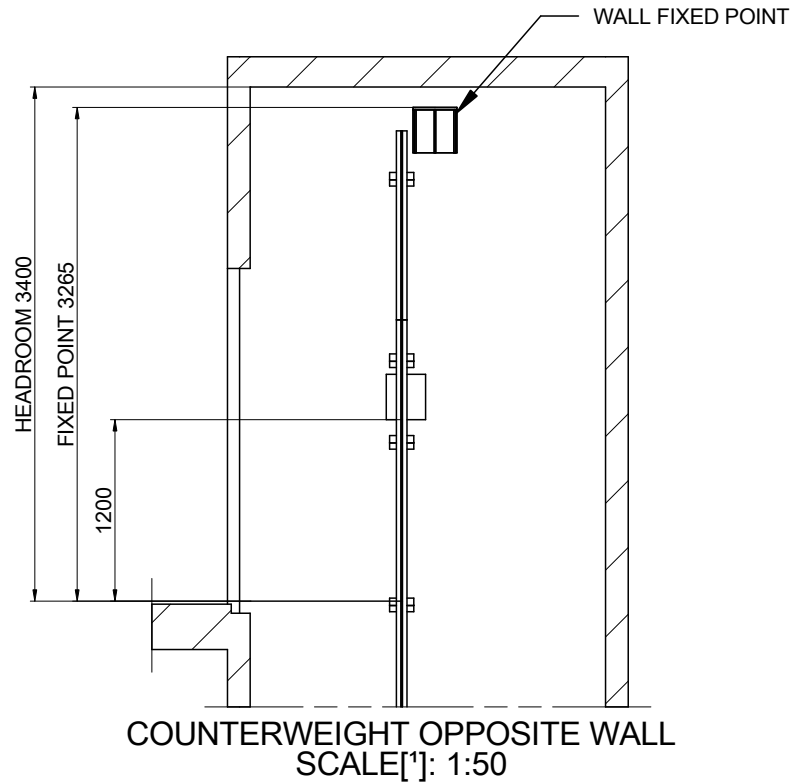

DRAWING	DATE	REV.	SHEET
MP	2017	00	4/8
MODEL LIFT:			
<b>MP GO! EVOLUTION</b>			
CAPACITY: [N° PERSONS]			13
NOMINAL LOAD: [kg]			1000
SPEED: [m/s]			1
FREQUENCY: [Hz]			50
TENSION: [V]		380V [Three-phase]	

[\*] Unbounded dimensions in drawings are indicative and not binding.

REFERENCE:  
MPGO!EVOLUTION1000ST2\_EN

CLIENT:  
WORK SITUATION:



**MP LIFTS**

# 04-BEAM AND LIFTING HOOKS

POSITION OF REMOVABLE LIFTING HOOKS ABLE TO SUPPORT  
2000 kg EACH ONE SUPPLIED BY CONSTRUCTOR  
(RECOMMENDED POSITION LOADHOOKS)

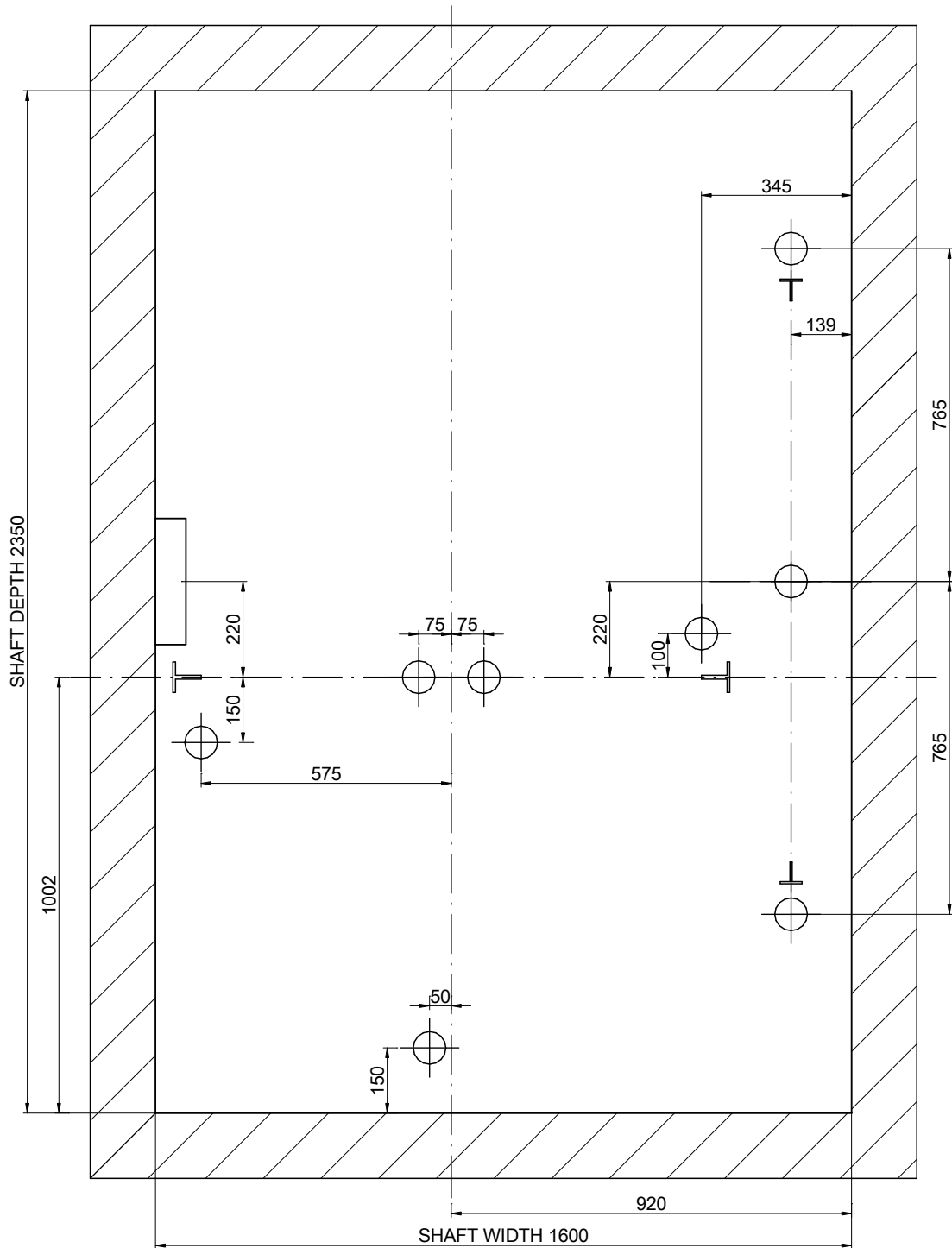

SCALE[\*]: 1:15

DRAWING	DATE	REV.	SHEET	[*] Unbounded dimensions in drawings are indicative and not binding.	
MP	2017	00	5/8		
MODEL LIFT:				REFERENCE:	
MP GO! EVOLUTION				MPGO!EVOLUTION1000ST2_EN	
CAPACITY: [N° PERSONS]				CLIENT:	
13				WORK SITUATION:	
NOMINAL LOAD: [kg]					
1000					
SPEED: [m/s]					
1					
FREQUENCY: [Hz]					
50					
TENSION: [V]					
380V [Three-phase]					
<b>MP LIFTS</b>					

# 05-PIT LAYOUT

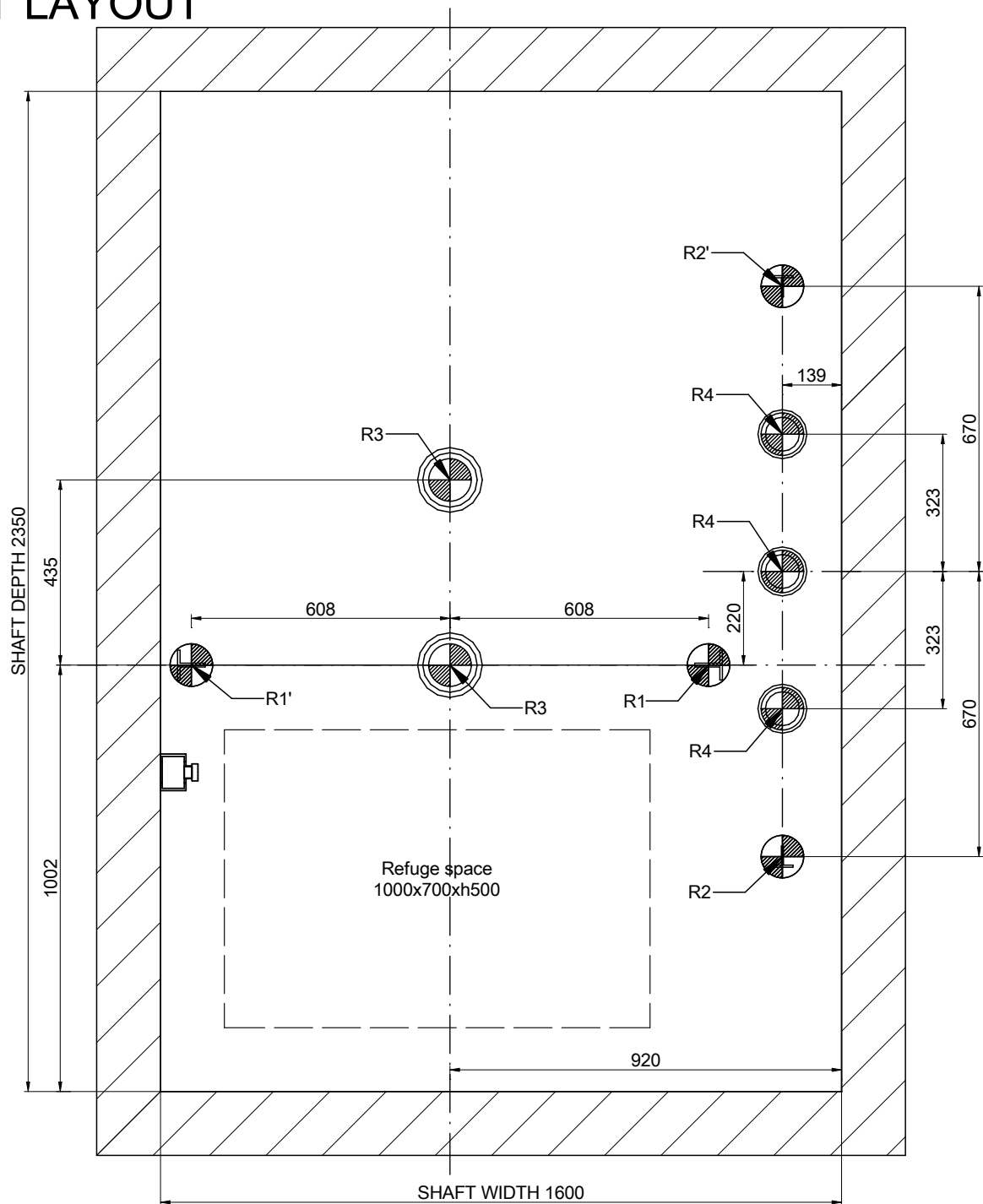

SCALE[\*]: 1:15

REACTIONS [N] [max.]			
R1	23000	R2	22000
R1'	23000	R2'	23000
R3	38000	R4	18800
N	2700	T	1000

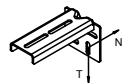

DRAWING	DATE	REV.	SHEET
MP	2017	00	6/8
MODEL LIFT:			
<b>MP GO! EVOLUTION</b>			
CAPACITY: [N° PERSONS]	13		
NOMINAL LOAD: [kg]	1000		
SPEED: [m/s]	1		
FREQUENCY: [Hz]	50		
TENSION: [V]	380V [Three-phase]		

[\*] Unbounded dimensions in drawings are indicative and not binding.

REFERENCE:  
MPGO!EVOLUTION1000ST2\_EN



CLIENT:  
WORK SITUATION:

**MP LIFTS**

# 06-DOOR HOLE DETAIL

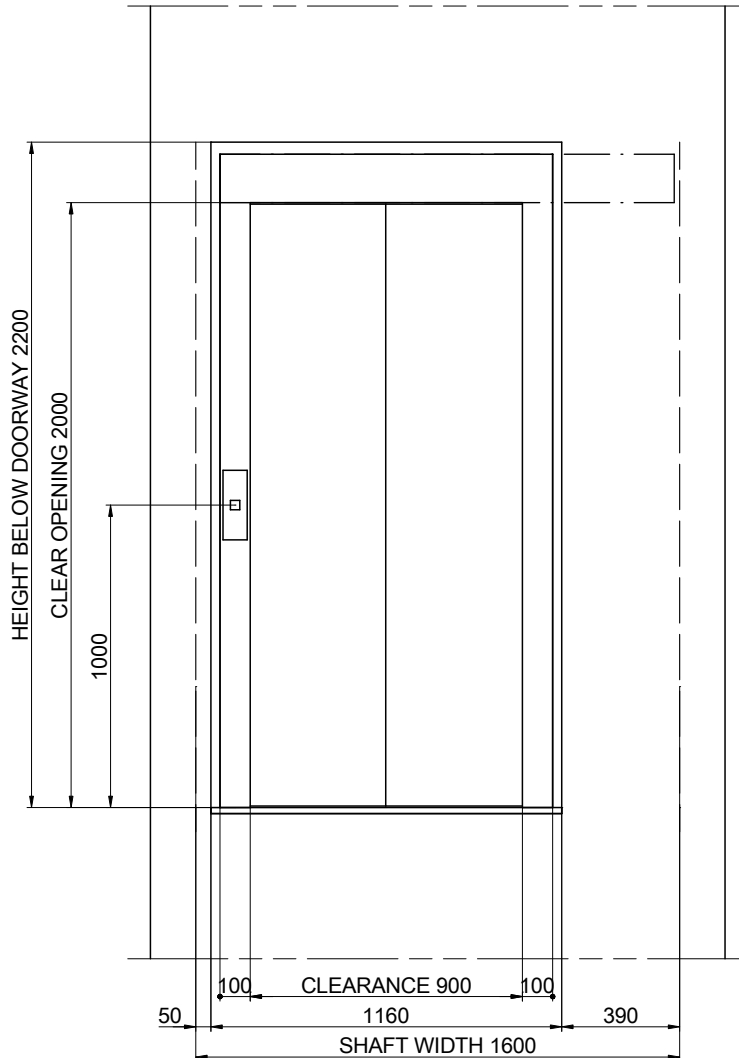

SCALE[\*]: 1:25

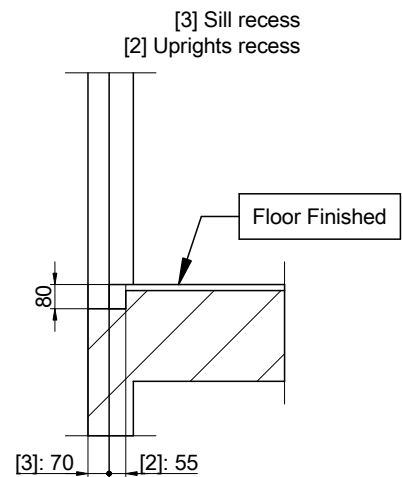

SCALE[\*]: 1:25

DRAWING	DATE	REV.	SHEET	[*] Unbounded dimensions in drawings are indicative and not binding.	
MP	2017	00	7/8	REFERENCE: MPGO!EVOLUTION1000ST2_EN	
MODEL LIFT:				CLIENT: WORK SITUATION:	
<b>MP GO! EVOLUTION</b>					
CAPACITY: [N° PERSONS]		13			
NOMINAL LOAD: [kg]		1000			
SPEED: [m/s]		1			
FREQUENCY: [Hz]		50			
TENSION: [V]		380V [Three-phase]		<b>MP LIFTS</b>	

# 07-HEADROOM

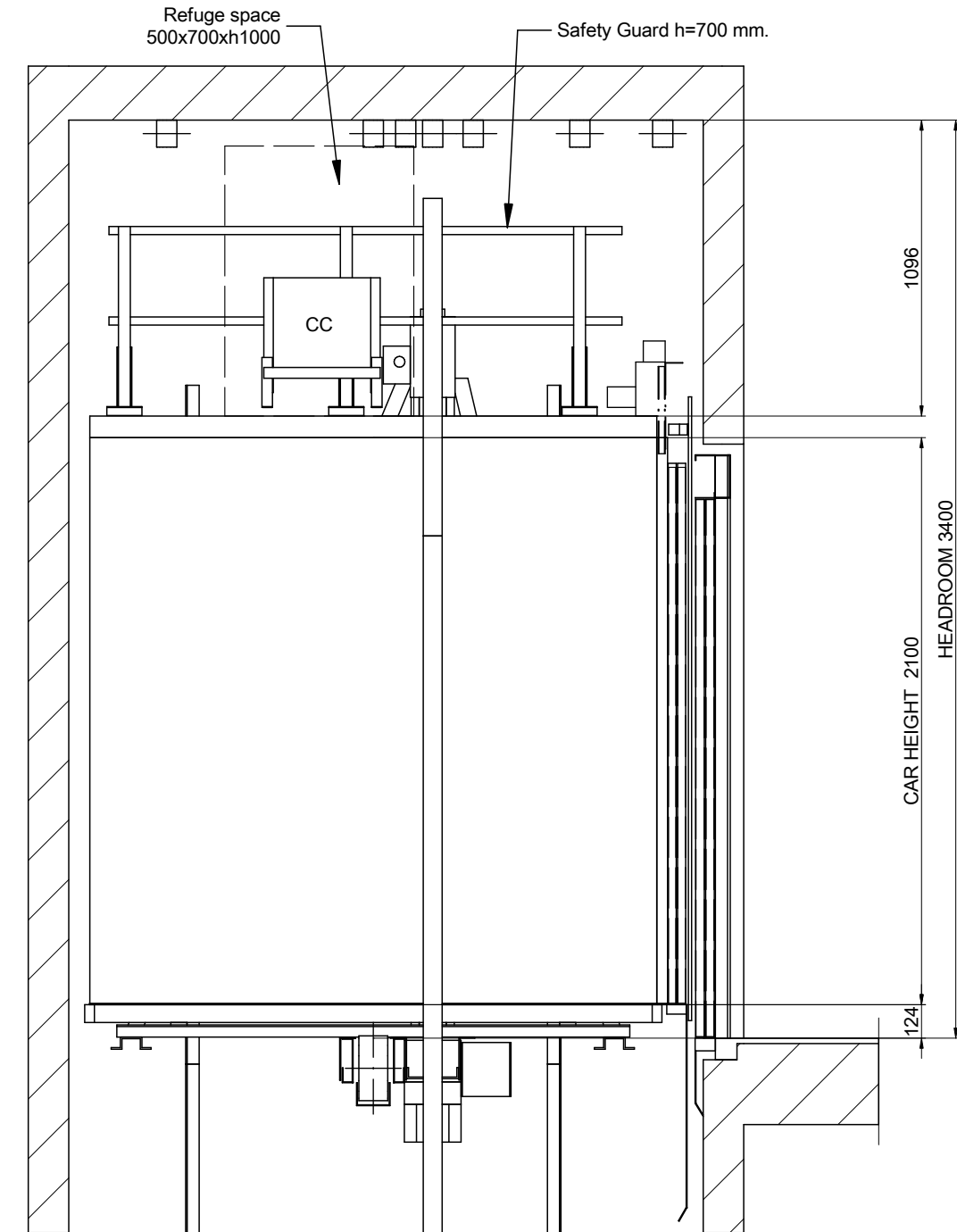

SCALE[\*]: 1:25

DRAWING	DATE	REV.	SHEET	[*] Unbounded dimensions in drawings are indicative and not binding.	
MP	2017	00	8/8		
MODEL LIFT:				REFERENCE:	
<b>MP GO! EVOLUTION</b>				MPGO!EVOLUTION1000ST2_EN	
CAPACITY: [N° PERSONS]				CLIENT:	
NOMINAL LOAD: [kg]				WORK SITUATION:	
SPEED: [m/s]					
FREQUENCY: [Hz]					
TENSION: [V]					
380V [Three-phase]					<b>MP LIFTS</b>